

**SAMSUNG**

# REFRIGERATOR

BOTTOM MOUNTED FREEZER TYPE

BASIC MODEL : RB31FERNCWW/EF

MODEL CODE : RB31FEJNB\*\*, RB31FERNB\*\*,  
RB31FEJNC\*\*, RB31FERNC\*\*,  
RB31FWJND\*\*, RB31FSJMD\*\*,  
RB31FSRMD\*\*, RB31FEJMD\*\*,  
RB31FERMD\*\*, RB29FEJNB\*\*,  
RB29FEJNC\*\*, RB29FERNC\*\*,  
RB29FWJND\*\*, RB29FWRND\*\*,  
RB29FSJMD\*\*, RB29FSRMD\*\*,  
RB29FEJMD\*\*, RB29FERMD\*\*

BOTTOM MOUNTED FREEZER TYPE

BASIC MODEL : RB37J5349SL/EF

MODEL CODE : RB37A5\*\*\*\*\*

# ***SERVICE*** Manual

## REFRIGERATOR



## CONTENTS

1. PRECAUTIONS (SAFETY WARNINGS).....	3
2. PRODUCT SPECIFICATIONS.....	6
3. DISASSEMBLY & REASSEMBLY .....	16
4. TROUBLE SHOOTING .....	40
5. PCB/PBA DAIGRAM .....	80
6. WIRING DIAGRAM.....	91
7. BLOCK DIAGRAM .....	95
8. REFERENCE INFORMATION .....	100



## **WARNING**

### **IMPORTANT SAFETY NOTICE**

The service guide is for service men with adequate backgrounds of electrical, electronic, and mechanical experience. Any attempt to repair a major appliance may result in personal injury and property damage. The manufacturer or dealer cannot be responsible for the interpretation of this information.

All rights reserved. This service guide may not be reproduced in whole or in part in any form without written permission from the SAMSUNG ELECTRONICS Company.

# 1. PRECAUTIONS (SAFETY WARNINGS)

- Upon electronic Control system repair/change, make sure the set unplugged.  
Be ware of electric shock.
- Use rated electronic Control equipment.  
Make sure to check out Model name, Rated voltage, Rated current, Operation Temp, etc.
- Upon repair, make sure that harnesses are not to be water-penetrated and are bundled tight. Should not be detached by a certain amount of external force.
- Upon repair, completely remove dust or other foreign substances from housing, harness, connector, etc.  
To prevent fire by tracking, short, etc.
- Check out whether water has penetrated into the electronic Control system.  
If there is any kind of trace, take necessary measures such as related component change, insulation tapping, etc.
- After repair, check out the assembled state of parts.  
It should be the same as the previous state.
- Check out the surrounding conditions.  
Change the location, if the fridge is located at humid, wet places or the installed state is unstable.
- If needed, ground the fridge.  
Especially, if there is a possibility of electric leakage, ground is indispensable.
- Do not allow consumers to overload a certain outlet.
- Check out whether the power cord or the outlet is broken, squeezed, chopped off or heat-deformed.  
Repair or replace the defective power cord/outlet immediately.  
Make sure the power cord is not punctuated or stomped down.
- Do not allow consumers to keep food unstable or place bottles in the Freezer Room.
- Do not allow consumers to repair the fridge for themselves.
- Do not allow consumers to keep things except for food.  
Pharmaceutical, Chemical substances : These are not possible to be fine-Controlled with a consumer fridge.  
Flammable material (alcohol, benzene, ether, LPG, etc) : possibility of explosion.







# 1. PRECAUTIONS (SAFETY WARNINGS)

Read all instructions before repairing the product and keep to the instructions in order to prevent danger or property damage.

## CAUTION/WARNING SYMBOLS DISPLAYED

	<b>Warning</b>	Indicates that a danger of death or serious injury exists.
	<b>Caution</b>	Indicates that a risk of personal injury or material damage exists.

## SYMBOLS

	means Prohibition".
	means Do not disassemble".
	means No contact".
	means The things to be followed".
	means Power cord should be unplugged from the consent".
	means Earth to prevent Electric shock".



## Warning & Caution

Use the rated components on the replacement.

- Check the correct model, rated voltage, rated current, operating temperature and so on.

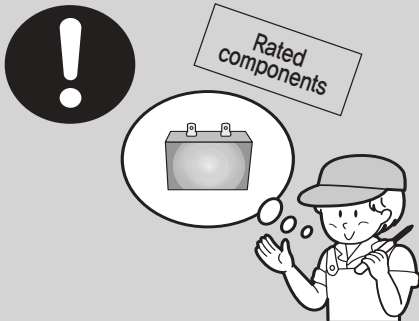

On repair, make sure that the wires such as harness are bundled tightly.

- Bundle tightly wires in order not to be detached by the external force and then not to be wetted.



On repair, remove completely dust or other things of housing parts, harness parts, and check parts.

- Cleaning may prevent the possible fire by tracking or short.



After repair, check the assembled state of components.

- It must be in the same assembled state when compared with the state before disassembly.



Check if there is any trace indicating the permeation of water.

- If there is that kind of trace, change the related components or do the necessary treatment such as taping using the insulating tape.

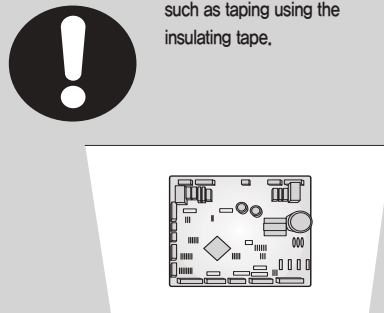

# 1. PRECAUTIONS (SAFETY WARNINGS)

※ Please let users know following warnings & cautions in detail.



## Warning & Caution

Do not allow users to put bottles or kinds of glass in the freezer.

- Freezing of the contents may inflict a wound.



Prohibition

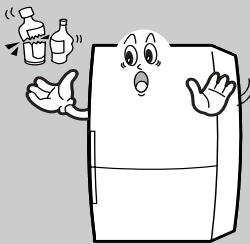

Do not allow users to store narrow and lengthy bottles or foods in a small multi-purpose room.

- It may hurt you when refrigerator door is opened and closed resulting in falling stuff down.



Prohibition



Do not allow users to store pharmaceutical products, scientific materials, etc., in the refrigerator.

- The products which temperature control should not be stored in the refrigerator.

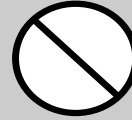

Prohibition



Do not allow users to insert the power plugs for many products at the same time.

- May cause abnormal generation of heat or fire.



Prohibition

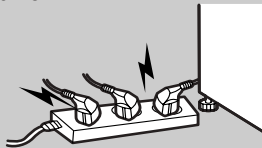

Do not allow users to disassemble, repair or alter.

- It may cause fire or abnormal operation which leads to injury.



Do not disassemble

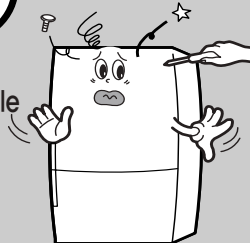

Do not allow users to bend the power cord with excessive force or do not have the power cord pressed by heavy article.

- May cause fire.



Do not allow users to store articles on the product.

- Opening or closing the door may cause things to fall down, with may inflict a wound.



Prohibition

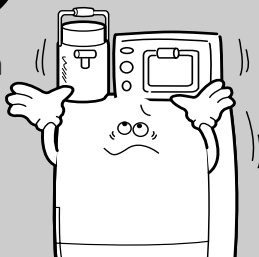

Do not allow users to install the refrigerator in the wet place or the place which water splashes.

- Deterioration of insulation of electric parts may cause electric shock or fire.

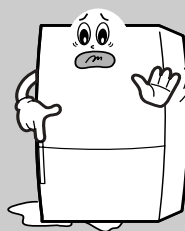

Make sure of the earth.

- If earthing is not done, it will cause breakdown and electric shock.



Earth

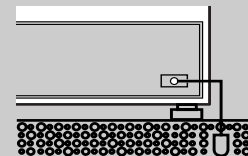



## 2. PRODUCT SPECIFICATIONS

2-1) Introduction of main function . . . . .	7
2-2) Model Specification . . . . .	8
2-3) Electric Part Specification . . . . .	11
2-4) Dimension (mm) . . . . .	15

## 2. PRODUCT SPECIFICATIONS

### 2-1) Introduction of main function

- SAMSUNG refrigerator has the following characteristics.

Characteristics	Specification
Environment-friendly fridge/freezer using R600a (RL43* MODEL ONLY)	<ul style="list-style-type: none"> <li>• This products protects the environment by using the R600a refrigerant and the cyclopentane blowing agent</li> <li>• Properties :ODP(Ozone Depletion Potential):0GWP : Lowest</li> <li>* GWP(Global Warming Potential)</li> </ul>
High -energy efficiency	<ul style="list-style-type: none"> <li>• Drawer for dry or wrapped food</li> <li>• Drawer for fresh salades,vegetables and fruits</li> </ul> 
Fridge at the top, drawer-type freezer at the bottom	<ul style="list-style-type: none"> <li>• The highly ergonomic vegetables compartment is placed at waist height as it is frequently used.</li> <li>• The drawer -type freezer minimize temperature variations and stores food cleanly and conveniently.</li> <li>• The operation switch is handy to switch the appliance on and off without pulling out the main plug.</li> </ul>
Digital temperature control display	<ul style="list-style-type: none"> <li>• The display shows all functions of the appliance, so that you can easily control them.</li> </ul>
Supply of cool water without door opening	<ul style="list-style-type: none"> <li>• With the water dispenser,you can obtain chilled water easily without opening the door. In addition, you can save electricty by more than 30%reducing the number of times the door is open.</li> </ul> 
LED LAMP	<ul style="list-style-type: none"> <li>• High Energy Efficiency, Long Life</li> </ul> 

## 2. PRODUCT SPECIFICATIONS

### 2-2) Model Specification

Item		SPECIFICATION			
Models		RB37A**9**	RB37A**5**	RB37A**0**	RB37A**1** (CIS)
Net Capacity	Total	365	367	367	367
	Refrigerator	267	269	269	269
	Freezer	98	98	98	98
Net dimension	W (mm)	595	595	595	595
	D (mm)	647	647	647	647
	H (mm)	2010	2010	2010	2010
Rated Voltage and Frequency		230V / 50HZ			
Motor Rated Consumption Power	c-fan	12v,3w	-	-	-
	r-fan	12v, 2.2w	-	-	-
	f-fan	12v, 2.2w	12v, 2.2w	12v, 2.2w	12v, 2.2w
Electric Heater Rated Consumption Power		230V, 150W			
Kind of Refrigerator		INDIRECT COOLING METHOD REFRIGERATOR			
Refrigerant/ Refrigerant Amount		73Gr	63Gr	63Gr	63Gr
Freezer Performance		4-STAR			
Product Weight		81.5kg	73.5kg	73.5kg	74.5kg



## 2. PRODUCT SPECIFICATIONS

Item		SPECIFICATION							
Models		RB31F****B	RB31F***C	RB31FD***D RB31FW***D	RB31F****D	RB29F****B	RB29F***C	RB29FD***D RB29FW***D	RB29F****D
Net Capacity	Total	304	304	308	310	286	286	288	290
	Refrigerator	206	206	210	212	188	188	190	192
	Freezer	98	98	98	98	98	98	98	98
Net dimension	W (mm)	595							
	D (mm)	664							
	H (mm)	1850				1780			
Rated Voltage and Frequency		230V / 50HZ							
Motor Rated Consumption Power	C-FAN	12V, 3W	-	-	-	12V, 3W	-	-	-
	F-FAN	12V, 2.2W							
Electric Heater Rated Consumption Power		230V, 150W							
Kind of Refrigerator		INDIRECT COOLING METHOD REFRIGERATOR							
Refrigerant/ Refrigerant Amount		R-600a							
		61 Gr	61 Gr	61 Gr	61 Gr	61 Gr	61 Gr	61 Gr	61 Gr
Freezer Performance		4-STAR							
Product Weight		65 kg	65 kg	65 kg	65 kg	63 kg	63 kg	63 kg	63 kg

## 2. PRODUCT SPECIFICATIONS



**NOTE**

This operation instruction covers various models.

The characteristics of your appliance may differ slightly from those described in this manual.

## 2. PRODUCT SPECIFICATIONS

### 2-3) Electric Parts Specification

		RB37A**9**	RB37A**5**	RB37A**0**	RB37A**1** (CIS)
Refrigerant		R-600a			
Freezing Capacity		* ** * 4-Star			
Compressor	Model	NC4MV/A1ALP/TT1	NC4MV/A1ALP/TT1	MSV4A1AL1R/TT1	MSV4A1AL1R/TT2
	Starting type	BLDC	BLDC	BLDC	BLDC
Evaporator		Oil Charge	200±10	200±10	200±10
Freezer		Split Fin Type			
Condenser (Convection Type)		forced type	convection type	convection type	convection type
Dryer		Molecular sieve XH-9			
Capillary Tube		OD1.8xID0.85xL3900 CU OD2.05xID0.75xL4500 CU	-	-	-
Defrost Heater		230V / 150W			
Thermal-Fuse for preventing overheating of Refrigerator Defrost-Heater		AC250V, 10A, 109~110°C			
Over-load Relay		4TM445PHBY-82			
Temp. ON		125°C ± 5			
Temp. OFF		69°C ± 9			
Rated Voltage		200 - 240V ~ 50Hz, 220V ~ 60Hz			
F ROOM		12035GE-12M-YT-F1			
R ROOM		12035GE-12M-YT-F1	-	-	-
C ROOM		G1538S12D1-SS-TTL			
R ROOM Damper		-	NSBA001TF1, DC12V, 60mA		
Lamp		DC12V, 65*10*1.6T, FR4, 3PKG			
Door Switch		Reed switch, DC 200V, 1.5A			
		Compon nents for Freezer			
		Electric Components			

## 2. PRODUCT SPECIFICATIONS

Refrigerant		R-600a					
Freezing Capacity		<div style="text-align: center;"> <b>***</b>            4-Star         </div>					
Compressor	Model	MSV488AL1P/TT1	MSV488AL1R/TT1	MSV488A-L1P	MSV488AL1R/TT1	MSV488AL1R/TT1	MSV488AL1R/TT1
	Starting type	BLDC	BLDC	BLDC	BLDC	BLDC	BLDC
Evaporator	Oil Charge	200 ± 10cc	200 ± 10cc	200 ± 10cc	200 ± 10cc	200 ± 10cc	200 ± 10cc
	Freezer	Split Fin Type					
Condenser (Convection Type)		Forced Type		Forced Type		Convection Type	
Dryer		Molecular Sieve XH-9					
Capillary Tube		Cu, φ1.8XID0.75XL4000	Cu, φ1.8XID0.75XL3500	Cu, φ1.8XID0.75XL4000	Cu, φ1.8XID0.75XL4000	Cu, φ1.8XID0.75XL3500	Cu, φ1.8XID0.75XL3500
Defrost Heater	Conducting at F Defros	230V / 150W					
Thermal-Fuse for preventing overheating of Refrigerator Defrost-Heater		AC250V, 10A, 109~110°C					
Over-load Relay	Model	4TM308RFBYY-82					
	Temp. ON	130°C ± 5					
	Temp. OFF	61°C ± 9					
Rated Voltage		200 - 240V ~ 50Hz, 220V ~ 60Hz					
Motor	F ROOM	12035QE12MY or DREP8020RA (DC 12V)					
	C ROOM	G1538S12D1-SS-TTL(DC 12V)	-	G1538S12D1-SS-TTL(DC 12V)	-	-	-
Damper	R ROOM Damper	NSBA001TF1, DC12V, 60mA					
	Cool Select Zone	NSBY001TE1, DC12V	-	NSBY001TE1, DC12V	-	-	-
Lamp	LED Type	DC 12V, 65*10*1.6T, FR4, 3PKG					
Door Switch		Reed switch, DC 200V, 1.5A					
Compon nents for Freezer				Electric Components			

## 2. PRODUCT SPECIFICATIONS

Items		Specification									
Model		RB37A**9**		RB37A**5**		RB37A**0**		RB37A**1** (CIS)			
Freezer	Temperature Selection	ON(°C)	OFF(°C)	ON(°C)	OFF(°C)	ON(°C)	OFF(°C)	ON(°C)	OFF(°C)	ON(°C)	OFF(°C)
	-23°C	-21	-25	-21	-25	-21	-25	-21	-25	-21	-25
	-19°C	-18	-22	-18	-22	-18	-22	-18	-22	-18	-22
Refrigerator	Temperature Selection	ON(°C)	OFF(°C)	ON(°C)	OFF(°C)	ON(°C)	OFF(°C)	ON(°C)	OFF(°C)	ON(°C)	OFF(°C)
	1°C	-1	3	-1	3	-1	3	-1	3	-1	3
	3°C	0.5	4.5	0.5	4.5	0.5	4.5	0.5	4.5	0.5	4.5
Defrost Cycle	Temperature Selection	ON(°C)	OFF(°C)	ON(°C)	OFF(°C)	ON(°C)	OFF(°C)	ON(°C)	OFF(°C)	ON(°C)	OFF(°C)
	7°C	4.5	8.5	4.5	8.5	4.5	8.5	4.5	8.5	4.5	8.5
	First Defrost Cycle (Concurrent defrost of F and F)	6 ± 10 min									
Defrost Cycle (FRE)		6~7hr(vary according to the conditions used)									
Pause time		5 ± 1 min									
Defrost Sensor		SENSOR TEMP-F DEF SENSOR									
Model		5.39 or 5.49 Kohm at 23°C									
SPEC		120V/250V, 15A/10A									
Rated		109 ~ 110°C									
Operating temperature											
Thermal-Fuse											
Room Temperature Sensor Components											
Defrost Related Components											

## 2. PRODUCT SPECIFICATIONS

Items		Specification																
Model	Temperature Selection	RB31FE***		RB31FE*** RB30FE***		RB31FD*** RB31FW***		RB31F*** RB32F***		RB29F***		RB29F*** RB28F***		RB29FD*** RB29FW***		RB29F*** RB28F***		
		ON(°C)	OFF(°C)	ON(°C)	OFF(°C)	ON(°C)	OFF(°C)	ON(°C)	OFF(°C)	ON(°C)	OFF(°C)	ON(°C)	OFF(°C)	ON(°C)	OFF(°C)	ON(°C)	OFF(°C)	
	-23°C		-21.0	-25.0	-21.0	-25.0	-21.0	-25.0	-21.0	-25.0	-21.0	-25.0	-21.0	-25.0	-21.0	-25.0	-21.0	-25.0
	-19°C		-18.0	-22.0	-18.0	-22.0	-18.0	-22.0	-18.0	-22.0	-18.0	-22.0	-18.0	-22.0	-18.0	-22.0	-18.0	-22.0
-15°C		-12.5	-16.5	-12.5	-16.5	-12.5	-16.5	-12.5	-16.5	-12.5	-16.5	-12.5	-16.5	-12.5	-16.5	-12.5	-16.5	
Model	Temperature Selection	ON(°C)	OFF(°C)	ON(°C)	OFF(°C)	ON(°C)	OFF(°C)	ON(°C)	OFF(°C)	ON(°C)	OFF(°C)	ON(°C)	OFF(°C)	ON(°C)	OFF(°C)	ON(°C)	OFF(°C)	
1°C		-1.0	3.0	-1.0	3.0	-1.0	3.0	-1.0	3.0	-1.0	3.0	-1.0	3.0	-1.0	3.0	-1.0	3.0	
3°C		0.5	4.5	0.5	4.5	0.5	4.5	0.5	4.5	0.5	4.5	0.5	4.5	0.5	4.5	0.5	4.5	
7°C		4.5	8.5	4.5	8.5	4.5	8.5	4.5	8.5	4.5	8.5	4.5	8.5	4.5	8.5	4.5	8.5	
First Defrost Cycle (Concurrent defrost of F and F)		6 ± 10 min																
Defrost Cycle (FRE)		6 ~ 56hr (vary according to the conditions used)																
Pause time		5 ± 1 min																
Model		SENSOR TEMP-F DEF SENSOR																
SPEC		5.39 or 5.49 Kohm at 23°C																
Rated		120V/250V, 15A/10A																
Operating temperature		109~110°C																
Room Temperature Sensor Components																		
Defrost Related Components																		

## 2. PRODUCT SPECIFICATIONS

### 2-4) Dimensions (mm)

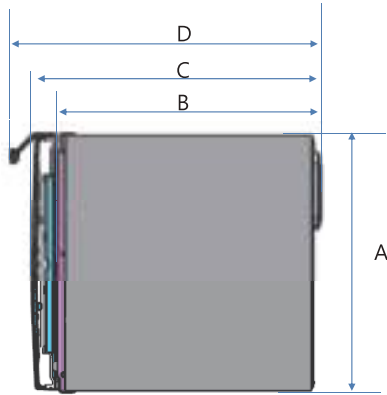

	A	B	C	D
BAR	600	609	669	719
RECESS	600	609	669	-

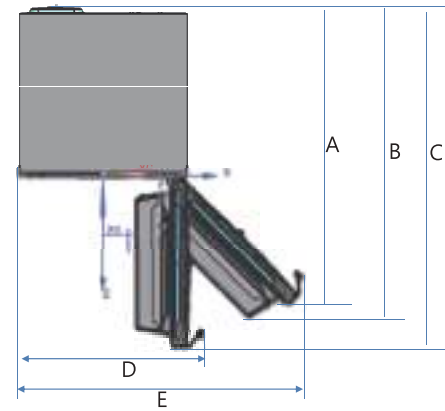

	A	B	C	D	E
BAR	1062	1107	1215	658	1015
RECESS	1059	1107	1209	609	992

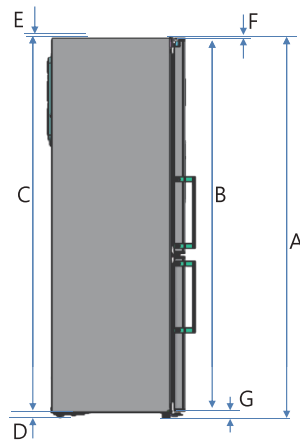

	A	B	C	D	E	F	G
RB31	1856	1821	1826	23	3	3	31
RB29	1786	1751	1756	23	3	3	31
RB37	2006	1971	1976	23	3	3	31

## 3. DISASSEMBLY & REASSEMBLY

3-1) Precaution . . . . .	17
3-2) Assy Door . . . . .	18
3-3) Door Sub parts . . . . .	20
3-4) Refrigerator Compartments . . . . .	22
3-5) Freezer Compartments . . . . .	23
3-6) Machine Compartment . . . . .	29
3-7) Compressor . . . . .	31
3-8) Reversing the Door swing . . . . .	32





## 3. DISASSEMBLY & REASSEMBLY

### 3-1) Precaution

- Unplug the refrigerator before cleaning and making repairs.
- Do not disassemble or repair the refrigerator by yourself.
  - You run risk of causing a fire, malfunction and/or personal injury.
- Remove any foreign matter or dust from the power plug pins.
  - Otherwise there is a risk of fire.
- Do not use a cord that shows cracks or abrasion damage along its length or at either end.
- Do not plug several appliances into the same multiple power board.
  - The refrigerator should always be plugged into its own individual electrical which has a voltage rating that matched the rating plate.
  - This provides the best performance and also prevents overloading house wiring circuits, which could cause a fire hazard from overheated wires.
- Do not install the refrigerator in a damp place or place where it may come in contact with water.
  - Deteriorated insulation of electrical parts may cause an electric shock or fire.
- The refrigerator must be grounded.
  - You must ground the refrigerator to prevent any power leakages or electric shocks caused by current leakage from the refrigerator.
- Do not put bottles or glass containers in the freezer.
  - When the contents freeze, the glass may break and cause personal injury.
- Do not store volatile or flammable substances in the refrigerator.
  - The storage of benzene, thinner, alcohol, ether, LP gas and other such products may cause explosions.

– NEED TOOL

IMAGE	ITEM	USE
	Phillips Head Driver	Use for assembling and disassembling of screw
	Flat Head Driver	Use for assembling and disassembling of HomeBar, Dispenser, Deli Cartessen Box, Main PBA etc...
	Socket Wrench Ø8mm, 12mm	Use for assembling and disassembling of Door Hinge

### 3. DISASSEMBLY & REASSEMBLY

#### 3-2) Assy Door





#### Removing the Refrigerator Door

PART NAME	FIGURE	DESCRIPTION
		<p>1. Remove the Cover Wire(①), Cap Space Door(②), Cover Hinge(③) using a flathead screwdriver.</p> <p> Be careful of injury.</p>
<p>Removig the Refrigerator Door</p>		<p>2. Remove hinge screws (③) by turning to counterclockwise, and take off the cover hinge (④) along the arrow.</p> <p> Take care when removing the door to ensure that it does not fall on you.</p>
		<p>3. Remove the door from the middle hinge by carefully lifting the door (⑤).</p> <p> Be careful not to scratch.</p>

### 3. DISASSEMBLY & REASSEMBLY



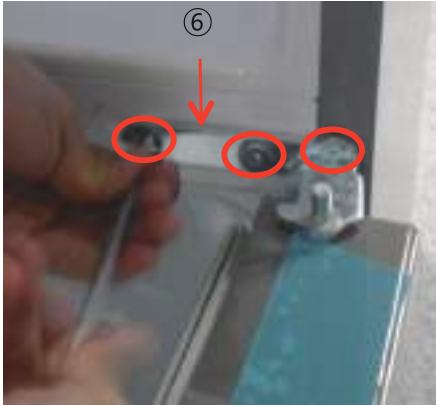





#### Removing the Freezer Door

PART NAME	FIGURE	DESCRIPTION
		<p>1. After unscrewing and removing two bolts, disassemble the ASSY HINGE MID (⑥).</p>
Removing the Freezer Door		<p>2. Remove the door by carefully lifting the door (⑦).</p> <p> Be careful not to scratch.</p>

### 3. DISASSEMBLY & REASSEMBLY

#### 3-3) Door Sub parts



PART NAME	FIGURE	DESCRIPTION
<b>Door Handle (Bar/Easy handle)</b>		<ol style="list-style-type: none"> <li>1. Insert a flat-head screwdriver on the slot as shown, and unlock the caps.</li> <li>2. Remove screws by turning to counterclockwise, and take off the Handle Assy by pulling out.</li> </ol>
<b>Door Gasket</b>		<p>The door gasket is a molded gasket set into a channel located in the door liner.</p> <ol style="list-style-type: none"> <li>1. Open the door.</li> <li>2. Grasp the gasket and pull in an outward motion until the molded gasket separates from the door liner.</li> </ol> <p> <b>Be careful of injury.</b></p>
<b>Door display (Fridge Option Item)</b>		<p><b>– Exterior Display</b></p> <ol style="list-style-type: none"> <li>1. Remove inlay film as shown.</li> <li>2. Insert a flat-head screwdriver on the slot as shown, and unlock the tabs.</li> <li>3. Disconnect the wire connector.</li> </ol> <p> <b>When disassembling, make sure the unit turned off.</b></p>
<b>Water Dispenser (Fridge Option Item)</b>		<ol style="list-style-type: none"> <li>1. Hold the top as shown in the picture and remove it by pulling it forward.</li> </ol>

### 3. DISASSEMBLY & REASSEMBLY

PART NAME	FIGURE	DESCRIPTION
<p><b>Water Dispenser (Fridge Option Item)</b></p>		<p>1. Hold it at both sides as shown in the picture and remove it by lifting it up.</p>

### 3. DISASSEMBLY & REASSEMBLY

#### 3-4) Refrigerator Compartments

PART NAME	FIGURE	DESCRIPTION
<p><b>Shelf</b></p>		<p>These shelves allow the storage of larger items and pull out for easy access.</p> <ol style="list-style-type: none"> <li>1. Lift it up and pull the shelf out to the front.</li> </ol>
<p><b>Plastic Drawers In Refrigerator</b></p>		<p>Drawers are designed for storage of fruits, vegetables and deli items. The drawers are located in the lower portion of the refrigerator.</p> <ol style="list-style-type: none"> <li>1. Remove 1 screw.</li> <li>2. Pull out the drawer as far as it goes.</li> <li>3. Tilt the drawer up and pull it out until it is removed.</li> </ol>

### 3. DISASSEMBLY & REASSEMBLY

#### 3-5) Freezer Compartments

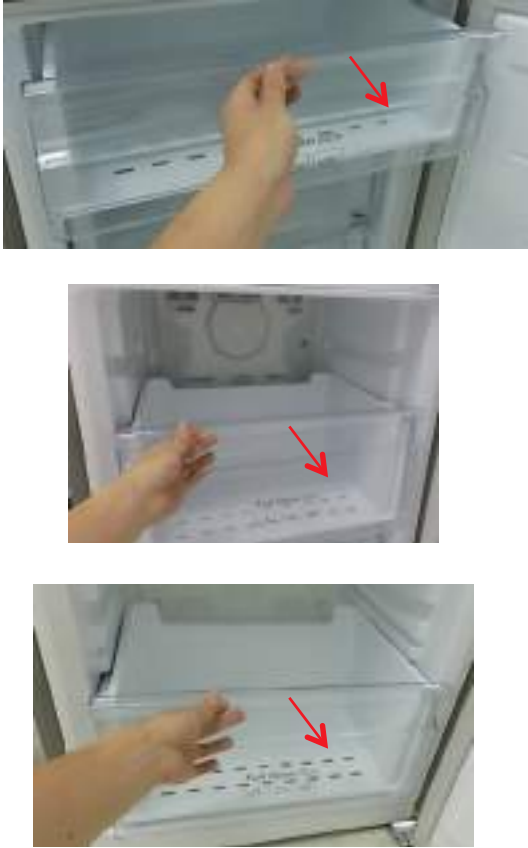
PART NAME	FIGURE	DESCRIPTION
<p><b>Plastic Drawer In Freezer</b></p>		<p>Drawers are designed for storage of meat and dry foods. The drawers are located in the lower portion of the refrigerator.</p> <ol style="list-style-type: none"><li>1. Pull out the drawer as far as it goes.</li><li>2. Tilt the drawer up and pull it out until it is removed.</li></ol>

### 3. DISASSEMBLY & REASSEMBLY

PART NAME	FIGURE	DESCRIPTION
<p>Assy Cover Evap (RB37A5**9**/** OR RB37A5**9**)</p>		<ol style="list-style-type: none"> <li>1. Remove all shelves, plastic drawer.</li> <li>2. Remove 6 screws, side of refrigerator as shown</li> <li>3. Open Cover conv multi by using tool and remove housing connector. When disassembling, make sure the unit turned off.</li> <li>4. Catch outlet part and Pull assy cover evap REF on one side of refrigerator as shown.</li> <li>5. Remove 2 screws and Pull assy case motor REF on one side of refrigerator as shown.</li> </ol> <p>– Refrigerator assembly order is the reverse of disassembly.</p>





### 3. DISASSEMBLY & REASSEMBLY

PART NAME	FIGURE	DESCRIPTION
<p><b>Assy Cover Multi</b></p>		<ol style="list-style-type: none"> <li>1. Remove all shelves, plastic drawer.</li> <li>2. Remove 7 screws, side of refrigerator as shown</li> <li>3. Open Cover conv multi by using tool and remove housing connector. When disassembling, make sure the unit turned off.</li> <li>4. Catch outlet part and Pull assy cover multi REF on one side of refrigerator as shown.</li> </ol> <p>– Refrigerator assembly order is the reverse of disassembly.</p>

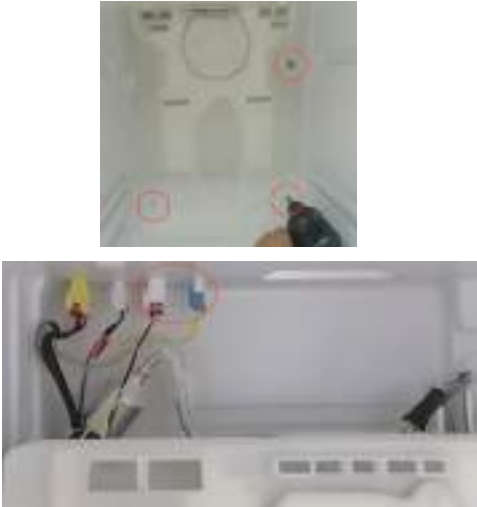
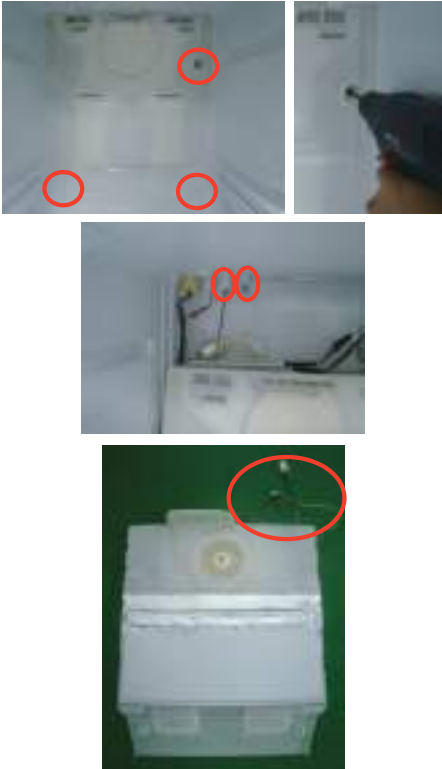

### 3. DISASSEMBLY & REASSEMBLY

PART NAME	FIGURE	DESCRIPTION
<p><b>Evaporator Cover In Freezer</b></p>		<ol style="list-style-type: none"> <li>1. Pull out all drawers.</li> <li>2. Remove 3 screws.</li> <li>3. Pull out the Shelf Fre Upp as far as it goes.</li> <li>4. Pull out the cover evap with 2 hands from bottom to top in order.</li> </ol> <p>When diassembling, make sure the unit turned off.</p>
<p><b>Fan Motor In Freezer</b></p>		<ol style="list-style-type: none"> <li>1. Remove 3 screws.</li> <li>2. Disengage 2 housing connectors.</li> <li>3. Unfasten wires.</li> </ol>

### 3. DISASSEMBLY & REASSEMBLY

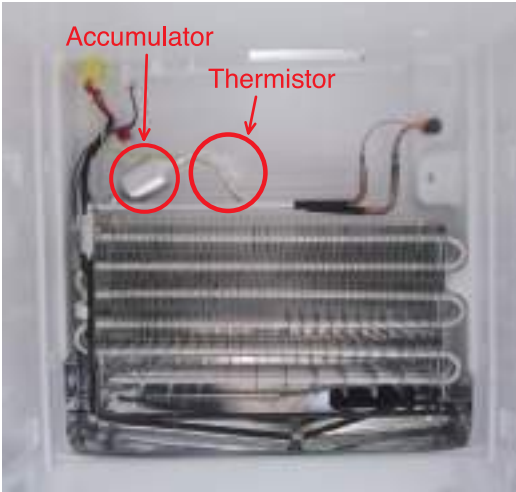

PART NAME	FIGURE	DESCRIPTION
<p>Fan Motor In Freezer</p>		<p>1. Pull back the plate and remove 1 screw.</p> <p>2. Disassemble the Cover Evap Front and Cover Evap REAR with flat-head screwdriver.</p>
		<p>Be careful in disassembly. The Screw is covered by Plate Cover Evap Rear.</p>
		<p>Remove 3 screws.</p>

### 3. DISASSEMBLY & REASSEMBLY

PART NAME	FIGURE	DESCRIPTION
<p><b>Evaporator In Freezer</b></p>		<p>Evaporator is located in the bottom of freezer to produce cold air driven across the evaporator Coils.</p> <ol style="list-style-type: none"> <li>1. Take off the ductwork in Freezer.</li> <li>2. Disconnect the wire connector. (Heater, thermal fuse and Thermistor.)</li> <li>3. Cut the pipes, desoldering is dangerous with R600a or R134a charged appliances.</li> <li>4. Remove the evaporator.</li> <li>5. Take the same steps to seal the system as mentioned earlier.</li> </ol> <p>The freezer thermistor is located at the upper left of freezer vent. It sends temperature signals to the microprocessor.</p>
<p><b>Cover Case Junction</b></p>		<p>Remove screw by turning to counterclockwise, and take off the Cover case junction by pulling out.</p>
<p><b>Cover Compressor</b></p>		<p>Remove 3 screws by turning to counterclockwise, and take off the Cover Compressor by pulling out. (It's only for A+++ Model.)</p>

# 3. DISASSEMBLY & REASSEMBLY

## 3-6) Machine Compartment

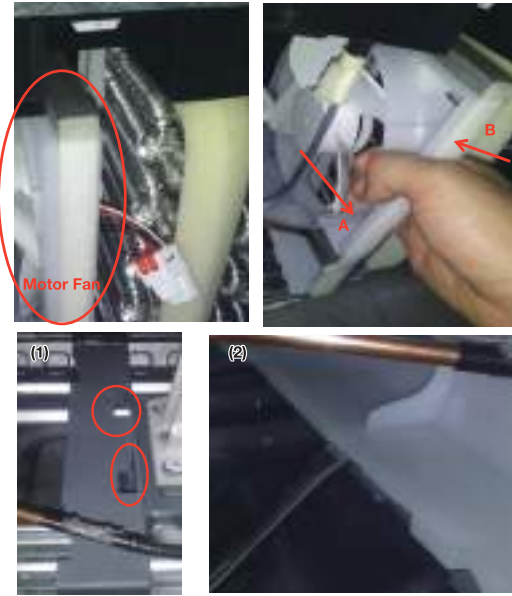
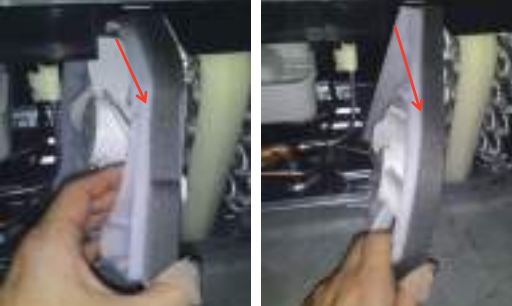



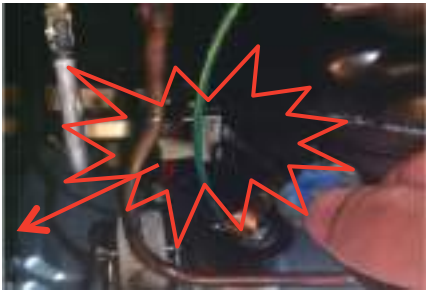

PART NAME	FIGURE	DESCRIPTION
		<p>1. Remove the Cover Comp.</p>
		<p>2. Disconnect the Wire Connector.</p>
<p><b>Motor Fan</b></p>		<p>3. After pulling the ASSY MOTOR FAN UNIT in the "A" direction and push it in the "B" direction, If it is hard to take it out, (1) insert a flat-head screwdriver (2) along the locking tabs located under the ASSY MOTOR FAN UNIT. And then, leverage it up and remove it.</p>
		<p>4. Remove it by pulling.</p>

### 3. DISASSEMBLY & REASSEMBLY

PART NAME	FIGURE	DESCRIPTION
Relay O/L		1. Remove Cover Relay.
		2. Remove the relay O/L with a flat-blade screwdriver. (Refer to the picture)

### 3. DISASSEMBLY & REASSEMBLY

#### 3-7) COMPRESSOR

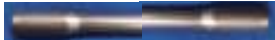
PART NAME	FIGURE	DESCRIPTION
COMPRESSOR		<p>1. Cut off the LOKRING connecting the COMP and the CONDENSER with a Pipe Cutter. (Red-line marking points)</p>
		<p>2. Cut off the LOKRING connecting the CONDENSER and the HOT PIPE with a Pipe Cutter. (Red-line marking points)</p>
		<p>3. Link the COMP and the CONDENSER with a PIPE-CONNECTOR (DA81-05659A) by brazing the joint areas.</p> <div style="display: flex; justify-content: space-around;">   </div>
		<p>4. Link the CONDENSER and the HOT PIPE with a PIPE-CONNECTOR (DA81-05659B) by brazing the joint areas.</p> <div style="text-align: center;">  </div>

# 3. DISASSEMBLY & REASSEMBLY

## 3-8) Reversing the Door swing

Read these instructions completely and carefully



- Before reversing the door, first of all, main power should be switched off. you should take out contents and accessories like door guard from the doors. Be careful not to drop the doors during dissembling or assembling.

1. Handle parts carefully to avoid scratching paint.
2. Set screws down by their related parts to avoid using them in the wrong places.
3. Provide a non-scratching work surface for the doors. (ex: blanket)
4. During door reversing, refrigerator should not be stained with oil.

NOT PROVIDED				ADDITIONAL PART	
Phillips Head Driver (+)	Flat Head Driver (-)	8mm Socket Wrench (for bolts)	11mm Wrench (for hinge shaft)	Hinge Cover / Cap Space Door	









PART NAME	FIGURE	DESCRIPTION
Removing the Refrigerator Door (Reversible)		1. Remove the Cover Wire Door.
	 	2. Disassemble the Cap space Door.



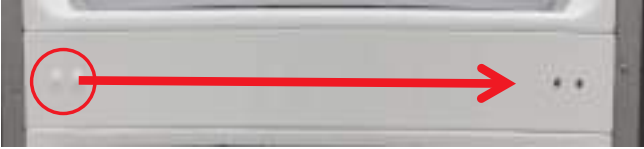

### 3. DISASSEMBLY & REASSEMBLY

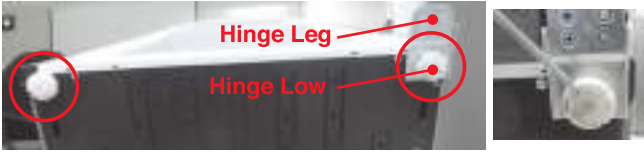
PART NAME	FIGURE	DESCRIPTION
Removing the Refrigerator Door (Reversible)		<p>3. Remove the Cover Hinge to push a hook like below Pictures.</p> <ul style="list-style-type: none"> <li>– Lift up the red line section by pressing as shown in Figure #2.</li> <li>– As shown in Figure #4, insert a flat-head screwdriver and push it in the arrow direction. (Take care not to damage the Cover Hinge Wire by pushing it too hard.)</li> <li>– Disassemble it by pushing the A in Figure #4 by hand as Figure #5.</li> </ul>
		<p>4. Disconnect the housing.</p>
		<p>5. Remove the screws. (Be careful not to be able to drop the Door when you disassemble it.)</p>
		<p>6. Remove the fridge door from the Middle hinge by carefully lifting the door straight up. Before you disassembly door, please remove guard.</p> <p> The door is heavy, be careful not to injure yourself when removing the door.</p>
		<p>7. Disassemble the Middle hinge by the Phillips Head (+) screwdriver.</p>

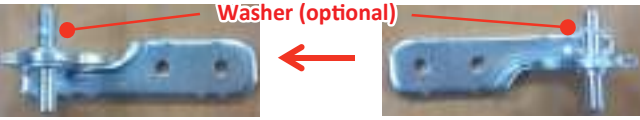



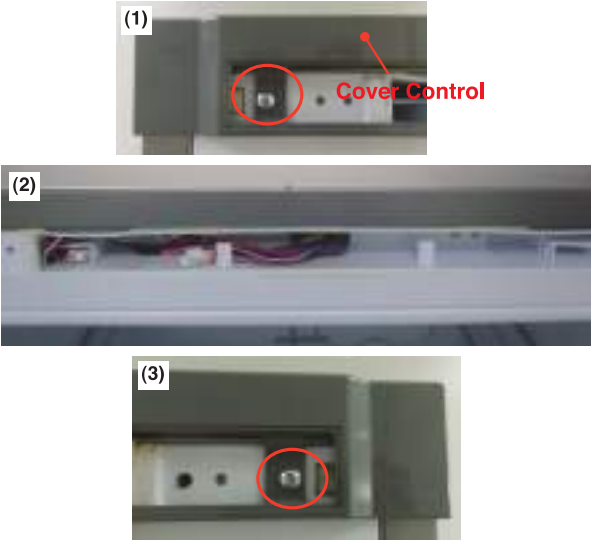

### 3. DISASSEMBLY & REASSEMBLY

PART NAME	FIGURE	DESCRIPTION
<b>Removing the Refrigerator Door (Reversible)</b>		<p>8. Remove the freezer door from the Bottom hinge by carefully lifting the door straight up.</p> <p> The door is heavy, be careful not to injure yourself when removing the door.</p>
	<p>Basic position</p>  <p>Position reversed</p> 	<p>9. Remove the screw on the bottom right side of the Fridge and Freezer Door Switch Lever Auto Closer from the right to the left. (Lever Auto closer, Screws each one.)</p>
		<p>10. Switch the Position of Cap screw and Cap.</p> <p> Be careful not to injure yourself during operation.</p>
		<p>11. Lay the refrigerator carefully. Remove the Leg and the Hinge Low.</p> <p><b>NOTE</b> To protect the refrigerator damage, cut a large section of the cardboard carton and place it under the refrigerator.</p>
	 	<p>12. Assemble the Middle hinge by the Phillips Head (+) screwdriver. (Assemble Washer upwardly before assembling Middle hinge.)</p>



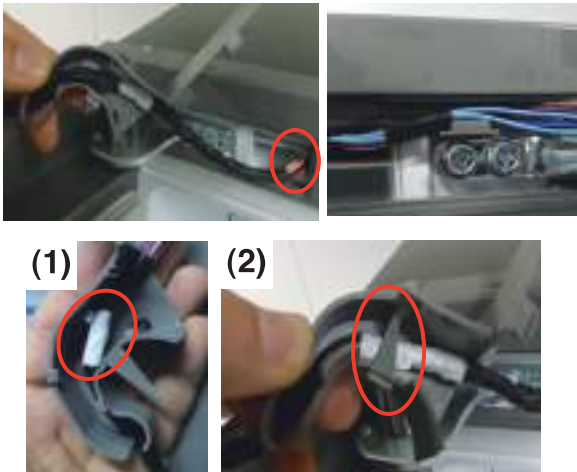

### 3. DISASSEMBLY & REASSEMBLY

PART NAME	FIGURE	DESCRIPTION
		<p>13. Switch the position of Bottom hinge and Leg. (Right → Left) Assemble the Hinge Low after putting the Freezer Door in the middle hinge.</p> <ul style="list-style-type: none"> <li>• Disassemble the Guide auto close and the Shaft-hinge.</li> <li>• Assemble the Shaft-hinge and the the Guide auto close like this Picture. The loosening power of HINGE SHAFT should be 30 Kg/cm or more.</li> <li>• Put the Cap-Control out from the Cover Control like the Picture.</li> </ul>
<p>Removing the Refrigerator Door (Reversible)</p>		<p>14. Remove the Screw and disassemble the Cover control (1), Switch the Wire door (2) direction to opposite side on Fridge Door (Door Display type only). Assemble the Cover-Control with Screw like a Picture (3).</p>
		<p>15. Switch the Wire-Door Direction to opposite side like the Picture.</p>



### 3. DISASSEMBLY & REASSEMBLY

PART NAME	FIGURE	DESCRIPTION
<b>Removing the Refrigerator Door (Reversible)</b>		<p>16. Use 11 mm wrench to separate the Top hinge shaft.            Flip the Top hinge and reattach the Top hinge shaft.            The loosening power of HINGE SHAFT should be 30 Kg/cm or more.</p>
		<p>17. Insert the Top hinge to make the hole a little bigger and then put out the Top hinge to assemble the Fridge door.</p> <p>Assemble step</p> <ol style="list-style-type: none"> <li>1. Assemble the Top hinge on the Fridge door.</li> <li>2. Assemble the Middle hinge on the Fridge door.</li> <li>3. Insert the Top Hinge on the Cabinet.</li> <li>4. Assemble the screw.</li> </ol>
	 <p>(1) </p> <p>(2) </p>	<p>18. Connect the wire and then insert it into the Cover-Control.            Insert the wire into the Cover Hinge and then the white taping part should be located as below picture (1).            Fold the Fixer not to disassemble as below picture (2).</p>
		<p>19. Assemble the Cover Hinge to match the Hinge.</p>

### 3. DISASSEMBLY & REASSEMBLY

PART NAME	FIGURE	DESCRIPTION
<p>Removing the Refrigerator Door (Reversible)</p>		<p>20. Assemble the Cap Space Door on back side.</p>
		<p>21. Insert the Cover Wire Door on the top of Fridge door and then push it to assemble completely. Check the wire position that should be located the back side of Cover Wire Door.</p>
		<p>22. Assemble the Cap Control.</p>
		<p>23. Switch the handles from the to left the right.</p>

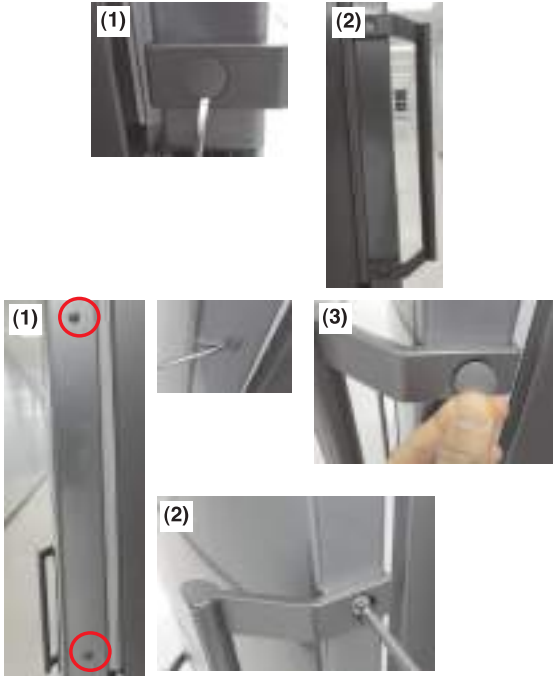
### 3. DISASSEMBLY & REASSEMBLY

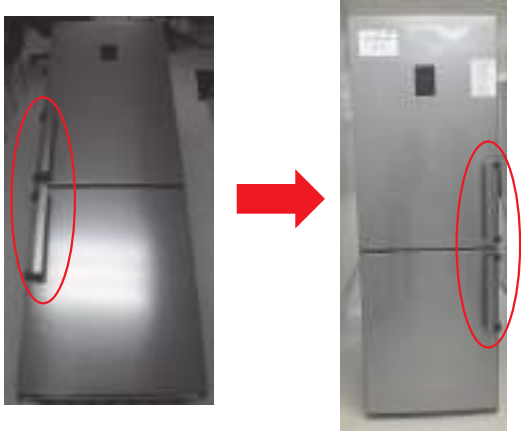
PART NAME	FIGURE	DESCRIPTION
		<p>24. Remove the Cap Handle and the Screws by Flat-Head (-) screwdriver.</p> <p>Remove the Cap by Flat-Head (-) screwdriver and assemble the Handle and Cap-Handle.</p> <p> Be careful the Scratch, when disassembling the Cap.</p>
<p>Removing the Refrigerator Door (Reversible)</p>		<p>25. Assemble the Cap.</p>
		

### 3. DISASSEMBLY & REASSEMBLY

PART NAME	FIGURE	DESCRIPTION
<p><b>Removing the Refrigerator Door (Reversible)</b></p>		<p>26. Detach the Fridge and Freezer gaskets and attach them after rotating 180°. Make sure the door gaskets are properly arranged. If not, there can be a noise or dew can be formed which affects performance of the unit.</p>
		<p>27. Make sure the doors are working properly.</p>

## 4. TROUBLESHOOTING

### 4-1) Check-List before Trouble-Shooting

4-1-1) Test Function (Forced Operation / Forced Defrost) . . . . .	41
4-1-2) Self-Diagnosis Function . . . . .	46
4-1-3) Load Status Display Function . . . . .	49
4-1-4) Restoration of Previous Settings upon Instant Power Outage . . .	51
4-1-5) Demo Mode Function for Store Display . . . . .	51
4-1-6) Option Setting Function . . . . .	52
4-1-7) Option Table . . . . .	55



## 4. TROUBLESHOOTING

### 4-1) Check-List before Trouble-Shooting

#### 4-1-1) Test Function (Forced Operation / Forced Defrost)

1. When pressing the "Freezer" and the "Fridge" buttons on the PANEL PCB at the same time for more than 4 seconds, the PANEL DISPLAY will be on and off with an interval of 0.5 second for about 3 seconds. At this time, release the "Freezer" and the "Fridge" buttons, and press the "Freezer" button. Then, it will go into the TEST MODE.
2. At the Test mode, all the display buttons will work as the Test button.
3. Each time the Test button is pressed, it will change in the following order.  
Twin : Forced operation 1 → Forced operation 2 (R Valve Close/ R Fan Off) → Forced operation 3 (F Valve Close/ F Fan Off) → Forced R defrost → Forced F/R defrost → Reset  
Mono : Forced Operation → Forced F-Defrost → Cancellation (Normal Operation)
4. It is recommended that the unit be re-plugged in to terminate the operation of the Test function.

#### 1) Test Mode Entering Process

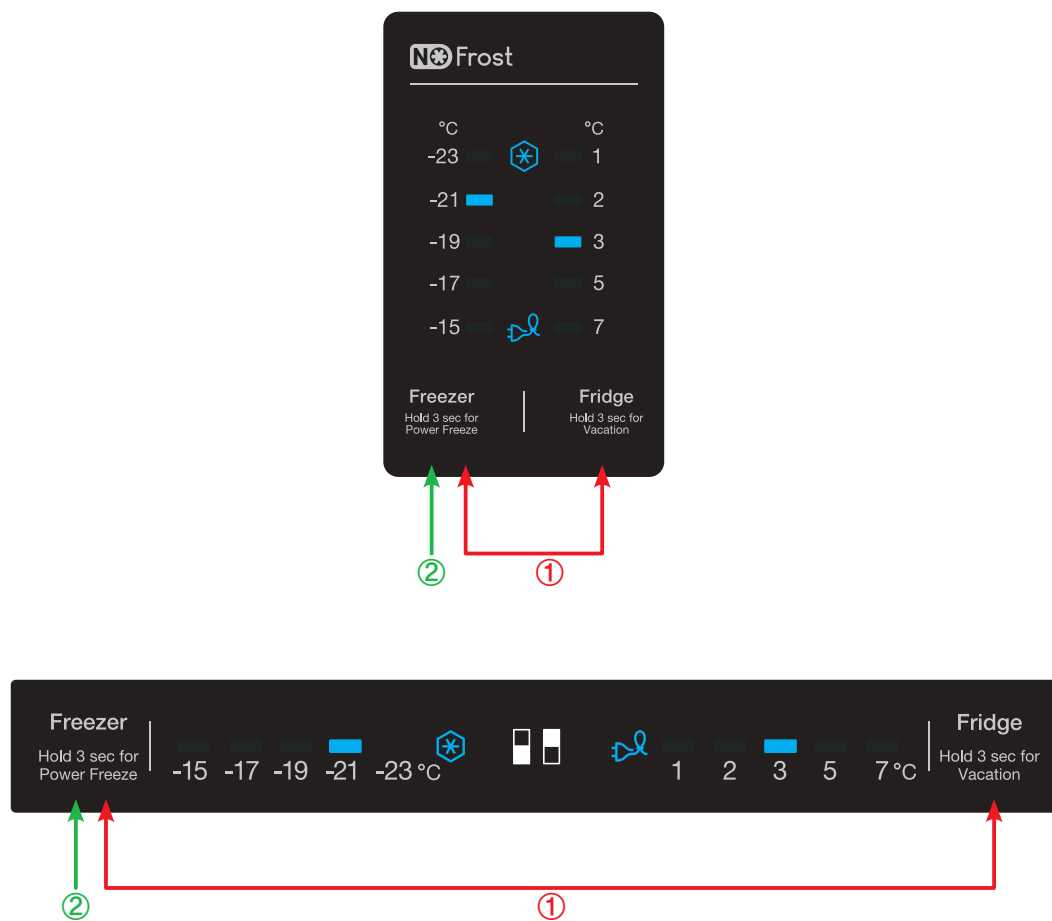

- ① Press the "Freezer" and the "Fridge" buttons at the same time for 4 seconds.
- ② When it is on the Test Mode, press the "Freezer" button once.

# 4. TROUBLESHOOTING

## 2) Test Mode Description

### 1. Forced Operation Function

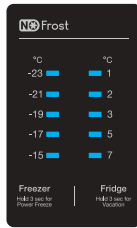

1-1) When any button is pressed once during the Test Mode, it will enter the Forced Operation.

When it starts the Forced Operation, the LED Lamps indicating the Fridge Temperatures (1°C, 2°C, 3°C, 5°C, 7°C) and the Freezer Temperatures (-23°C, -21°C, -19°C, -17°C, -15°C) will be on showing that it is on the Forced Operation.

At this time, it starts alarming with “Beep” sounds.

1-2) When the Forced Operation is selected, the compressor starts without a 7-minute delay in any operation mode.

At this time, when it is in a Defrost mode, it stops defrosting and the Forced Operation begins. (If the Forced Operation begins as soon as the compressor stops, it may cause the overload. So, take care when entering into the Forced Operation.)

1-3) When the Forced Operation is selected, the compressor and the F-Fan operate for 24 hours without stopping.

1-4) When the unit is shifted to the Forced Operation, the Freezer and the Fridge temperatures will be automatically set to -23°C and 1°C respectively.

1-5) When the Forced Operation is selected, the Power Freeze function won't work. (All the buttons will operate normally.) And, when the Power Freeze function is selected, the Power Freeze LED will go off in 10 seconds.

1-6) When the Forced Defrost or Test Cancellation Mode is selected within a minute with the Forced Operation being selected, the set temperature will be changed to the previously set operating temperature.

1-7) The alarm sound during the Forced Operation keeps on until the Forced Operation completes and there is no cancellation function.

### 2. Forced Defrost Function

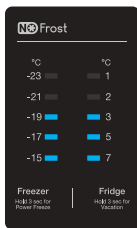

2-1) When it is on the Forced Operation during the Test Mode, press any button once. Then, the Forced Operation will stop immediately and it will go into the Forced F-Defrost. When it enters the Forced F-Defrost, it indicates that it is on the Forced F-Defrost mode by turning on "3°C", "5°C" and "7°C" temperature LEDs on the Fridge Display Panel and "-15°C", "-17°C" and "-19°C" temperature LEDs on the Freezer Display Panel.

2-2) At this time, it sends out "Beeping" sound for 3 seconds.

This alarm sound repeats 0.75 sec On and 0.25 sec Off which keeps on until the Forced F-Defrost finishes.

### 3. Test Cancellation Mode

3-1) When turning the display panel into the Test mode and pressing the TEST button once more during the Forced F-Defrost, the Forced F-Defrost will be cancelled and it will go back to the normal operation. Also, when the unit is plugged out and in again, the Test mode is to be deactivated.

## 4. TROUBLESHOOTING

### 2) Test mode Description – Twin

#### 1. Forced Operation Function 1

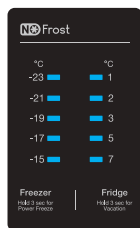

1-1) When any button is pressed once during the Test Mode, it will enter the Forced Operation.

When it starts the Forced Operation, the LED Lamps indicating the Fridge Temperatures (1°C, 2°C, 3°C, 5°C, 7°C) and the Freezer Temperatures (-23°C, -21°C, -19°C, -17°C, -15°C) will be on showing that it is on the Forced Operation.

At this time, it starts alarming with “Beep” sounds.

1-2) When the Forced Operation is selected, the compressor starts without a 10-minute delay in any operation mode.

At this time, when it is in a Defrost mode, it stops defrosting and the Forced Operation begins. (If the Forced Operation begins as soon as the compressor stops, it may cause the overload.

So, take care when entering into the Forced Operation.)

1-3) When the Forced Operation is selected, the compressor and the F-Fan operate for 24 hours without stopping.

1-4) When the unit is shifted to the Forced Operation, the Freezer and the Fridge temperatures will be automatically set to -23°C and 1°C respectively.

1-5) When the Forced Operation is selected, the Power Freeze function won't work.

(All the buttons will operate normally.) And, when the Power Freeze function is selected, the Power Freeze LED will go off in 10 seconds.

1-6) When the Forced Defrost or Test Cancellation Mode is selected within a minute with the Forced Operation being selected, the set temperature will be changed to the previously set operating temperature.

1-7) The alarm sound during the Forced Operation keeps on until the Forced Operation completes and there is no cancellation function.

#### 2. Forced Operation Function 2



1-1) When it is on the Forced Operation 1 during the Test Mode, press any button once. Then, Forced Operation 1 will stop immediately and it will go into the Forced Operation 2.

When it enters the Forced Operation 2, it indicates that it is on the Forced Operation 2 mode by turning on “7°C”, “5°C”, and “3°C” temperature LEDs on the Fridge Display Panel and “-15°C”, “-17°C” and “-19°C” temperature LEDs on the Freezer Display Panel

1-2) When the Forced Operation is selected, the compressor starts without a 10-minute delay in any operation mode.

At this time, when it is in a Defrost mode, it stops defrosting and the Forced Operation begins. (If the Forced Operation begins as soon as the compressor stops, it may cause the overload.

So, take care when entering into the Forced Operation.)

1-3) When the Forced Operation 2 is selected, the compressor and the F-Fan operate for 24 hours without Stopping and R Valve is closed and R-Fan stop for 24 hours

1-4) When the unit is shifted to the Forced Operation, the Freezer and the Fridge temperatures will be automatically set to -23°C and 1°C respectively.

1-5) When the Forced Operation is selected, the Power Freeze function won't work.

(All the buttons will operate normally.) And, when the Power Freeze function is selected, the Power Freeze LED will go off in 10 seconds.

1-6) When the Forced Defrost or Test Cancellation Mode is selected within a minute with the Forced Operation being selected, the set temperature will be changed to the previously set operating temperature.

1-7) The alarm sound during the Forced Operation keeps on until the Forced Operation completes and there is no cancellation function.

## 4. TROUBLESHOOTING

### 3. Forced Operation Function 3



1-1) When it is on the Forced Operation 2 during the Test Mode, press any button once. Then, Forced Operation 2 will stop immediately and it will go into the Forced Operation 3, when it enters the Forced Operation 3, it indicates that it is on the Forced Operation 3 mode by turning on “7°C” and “5°C” temperature LEDs on the Fridge Display Panel and “-15°C” and “-17°C” temperature LEDs on the Freezer Display Panel

1-2) When the Forced Operation is selected, the compressor starts without a 10-minute delay in any operation mode. At this time, when it is in a Defrost mode, it stops defrosting and the Forced Operation begins. (If the Forced Operation begins as soon as the compressor stops, it may cause the overload. So, take care when entering into the Forced Operation.)

1-3) When the Forced Operation 3 is selected, the compressor and the F-Fan operate for 24 hours without Stopping and F Valve is closed and F-Fan stop for 24 hours

1-4) When the unit is shifted to the Forced Operation, the Freezer and the Fridge temperatures will be automatically set to -23°C and 1°C respectively.

1-5) When the Forced Operation is selected, the Power Freeze function won't work. (All the buttons will operate normally.) And, when the Power Freeze function is selected, the Power Freeze LED will go off in 10 seconds.

1-6) When the Forced Defrost or Test Cancellation Mode is selected within a minute with the Forced Operation being selected, the set temperature will be changed to the previously set operating temperature.

1-7) The alarm sound during the Forced Operation keeps on until the Forced Operation completes and there is no cancellation function.

### 4. Forced R-defrost

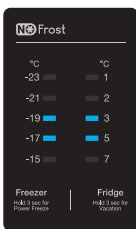

2-1) When it is on the Forced Operation 3 during the Test Mode, press any button once. Then, Forced Operation 3 will stop immediately and it will go into the Forced R-Defrost, when it enters the Forced R Defrost, it indicates that it is on the Forced R-defrost mode by turning on “5°C” and “3°C” temperature LEDs on the Fridge Display Panel and “-17°C” and “-19°C” temperature LEDs on the Freezer Display Panel

2-2) At this time, it sends out “Beeping” sound for 2 seconds. This alarm sound repeats 0.1 sec On and 0.9 sec Off which keeps on until the Forced R-Defrost finishes

## 4. TROUBLESHOOTING

### 5. Forced FR–defrost



2-1) When it is on the Forced R–defrost during the Test Mode, press any button once. Then, Forced R–defrost will stop immediately and it will go into the Forced FR–Defrost, when it enters the Forced FR Defrost, it indicates that it is on the Forced FR–defrost mode by turning on “3°C” temperature LEDs on the Fridge Display Panel and “–19°C” temperature LEDs on the Freezer Display Panel

2-2) At this time, it sends out “Beeping” sound for 2 seconds. This alarm sound repeats 0.5 sec On and 0.5 sec Off which keeps on until the Forced FR–Defrost finishes

### 6. Test Cancellation Mode

3-1) When turning the display panel into the Test mode and pressing the TEST button once more during the Forced FR–Defrost, the Forced FR–Defrost will be cancelled and it will go back to the normal operation. Also, when the unit is plugged out and in again, the Test mode is to be deactivated

## 4. TROUBLESHOOTING

### 4-1-2) Self-Diagnosis Function

#### 1) Self-Diagnosis Function upon Initial Power-On

- 1-1) When the unit is plugged into the power, MICOM diagnoses the status of the temperature sensors in a few minutes.
- 1-2) If defective sensor is found after Self-Diagnosis, relevant Display LEDs will blink at an interval of 0.5 sec. and there will be no beeping sound. (Refer to the Self-Diagnosis Check List)
- 1-3) When there is a defective sensor found and its relevant LED blinks, it will only recognize the Self-Diagnosis button combination and it doesn't do the normal display. But, the temperature will be controlled with the Emergency Operation.
- 1-4) To cancel the error code, fix the failure of the defective sensor or cancel the Initial Self-Diagnosis Function by pressing the Freezer and the Fridge buttons for 13 seconds.

#### 2) Self-Diagnosis Function during Normal Operation

- 2-1) During the Normal Operation, press the Freezer + Fridge buttons for 7 seconds. Then, the "2°C, 3°C and 5°C" Fridge temperature LEDs and the "-17°C, -19°C and -21°C" Freezer temperature LEDs on the Display Panel will blink at the interval of 0.5 seconds for 3 seconds. When pressing the Freezer and the Fridge buttons at the same time for 10 seconds including the 3-second Display On/Off time, the Fridge "3°C" and the Freezer "-19°C" Temperature LEDs will blink for 3 seconds with an interval of 0.5 second. At this time, when pressing the Freezer and the Fridge buttons at the same time for 13 seconds including the 3-second blinking time, it will send out a "Ding-Dong" buzzer sound and go into the Self Diagnosis Function.
- 2-2) When it goes into the Self-Diagnosis, the entire display panel goes off and when there is an error occurred, it will last for 60 seconds continuously and go to the normal operation whether or not the error is fixed. (It sends out "Ding-Dong" sound) (Refer to the Self-Diagnosis Check List below)
- 2-3) Buttons won't work during Self-Diagnosis.

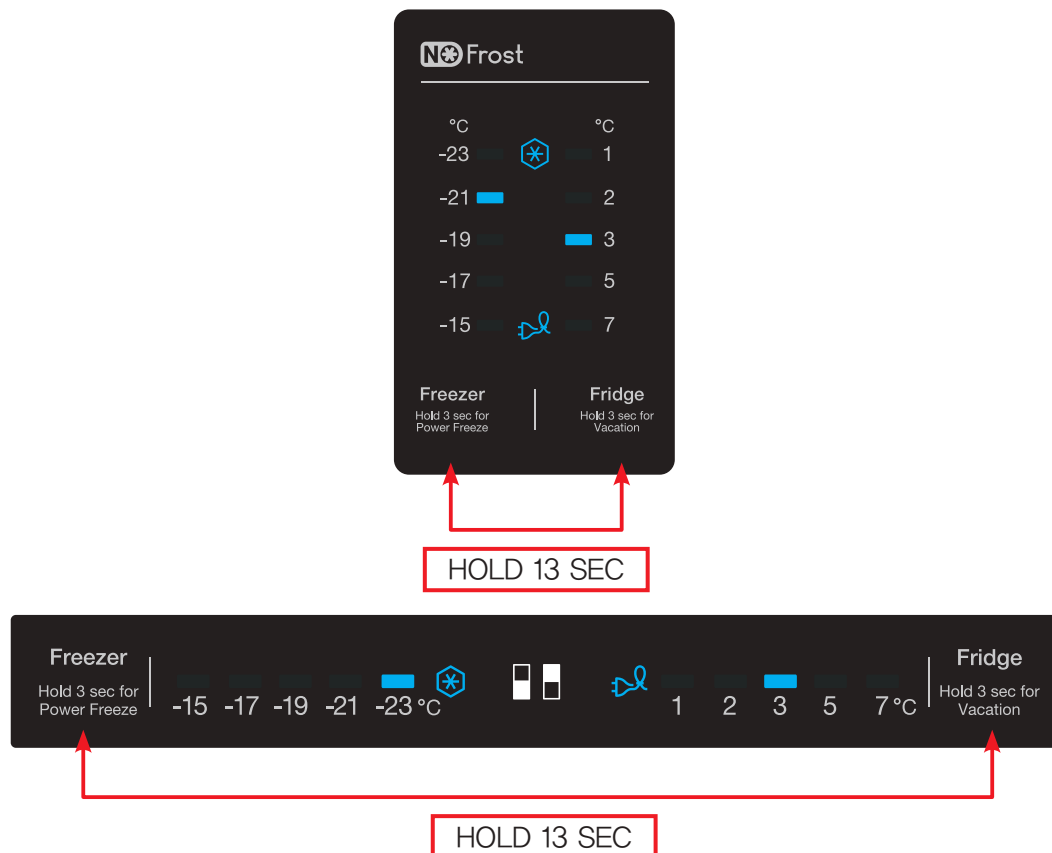

## 4. TROUBLESHOOTING

### ※ Self-Diagnosis Check List

NO	Defect Item	Description	ERROR CODE (Temp Display)
1	F-DEF ERROR	Freezer Room Defrost Heater Error	Freezer "-23°C" LED LAMP
2	EXT – SENSOR	External SENSOR Error	Freezer "-21°C" LED LAMP
3	F – SENSOR	Freezer Room SENSOR Error	Freezer "-19°C" LED LAMP
4	R – SENSOR	Fridge Room SENSOR Error	Freezer "-17°C" LED LAMP
5	F – DEF – SENSOR	Freezer Defrost SENSOR Error	Freezer "-15°C" LED LAMP
6	R – DEF – SENSOR	Fridge Defrost SENSOR Error	"Vacation" LED LAMP
7	F_FAN-SENSOR	Freezer Defrost SENSOR Error	Fridge "1°C" LED LAMP
8	C-FAN ERROR	Machine Room Fan Motor Error	Fridge "2°C" LED LAMP
9	R-FAN ERROR	Fridge Room Fan Motor Error	"Power Freezer" LED LAMP
10	COMP Run failure ERROR	COMP Run failure ERROR	Fridge "3°C" LED LAMP
	COMP IPM FAULT ERROR	COMP IPM FAULT ERROR	
	COMP ABNORMAL CURRENT ERROR	COMP Location detection ERROR	
	COMP MOTOR RESTRICTION ERROR	COMP MOTOR Bind ERROR	
	COMP Low Voltage ERROR	COMP Low Voltage ERROR	
	COMP Over Voltage ERROR	COMP Over Voltage ERROR	

## 4. TROUBLESHOOTING

### ※ Self-Diagnosis Error Description

NO	Error Code	Item	Description	Trouble Shooting
1	-23	F-DEF ERROR	[ Freezer Defrost Heater ] Connector Slipped-Out or Open-Contact, Wire Cut or Short-Circuited, Defective Thermistor [Fridge Defrost] When the defrosting does not complete even after it does defrosting for more than 120 minutes.	Remove the MAIN PCB CN70 and CN77 connectors from the MAIN PCB and read the continuity between BROWN ↔ ORG wires. (It differs according to the energy consumption.) When it reads 0 Ohm, check the Heater short and when it reads ∞ Ohm, check if the Wire/Thermal Fuse or the Bimetal is Open.
2	-21	EXT - SENSOR	Connector Slipped-Out or Open-Contact, Wire Cut or Short-Circuited, Abnormal Sensing Temp (higher than +65°C or lower than -50°C)	The voltage between MAIN PCB CN30-"2(WHT) ↔ 1(WHT)" should be within 4.5V~0.5V
3	-19	F-SENSOR	Connector Slipped-Out or Open-Contact, Wire Cut or Short-Circuited, Abnormal Sensing Temp (higher than +65°C or lower than -50°C)	The voltage between MAIN PCB CN30-"3(GRN) ↔ 1(WHT)" should be within 4.5V~0.5V
4	-17	R-SENSOR	Same as the EXT - SENSOR	The voltage between MAIN PCB CN30-"5(BLU) ↔ 1(WHT)" should be within 4.5V~0.5V
5	-15	F - DEF - SENSOR	Same as the EXT - SENSOR	The voltage between MAIN PCB CN30-"4(YEL) ↔ 1(WHT)" should be within 4.5V~0.5V
6	Vacation LED Lad	R-DEF-SENSOR	Same as the EXT - SENSOR	The voltage between MAIN PCB CN30-"4(YEL) ↔ 1(WHT)" should be within 4.5V~0.5V
7	1	F-FAN ERROR	Same as the EXT-Sensor	The voltage between MAIN PCB CN30-"6(RED) ↔ 7(Gray)" should be within 4.5V~0.5
8	2	C-FAN ERROR	When the related Fan Motor operates, it occurs if the contact of the Feed Back Signal Wire is defective, the Motor Wire is slipped out or the Motor is defective.	The voltage between MAIN PCB CN75-"2(BLU) ↔ 1(GRY)" should be within 7V~12V
9	Power Freeze LED LAMP	R-FAN ERROR	When the related Fan Motor operates, it occurs if the contact of the Feed Back Signal Wire is defective, the Motor Wire is slipped out or the Motor is defective.	The voltage between MAIN PCB CN75-"3(ORG) ↔ 1(GRY)" should be within 6V~12V
10	3	Comp start failure error	The error code is displayed when the compressor has failed to start.	Check the soldering status of the inverter PCB. (Check if any parts have short-circuited). Check if the DC 16V output is less than 1 3.5V. Check the Comp and Cycle.
		Compressor IPM Fault Error	The error code is displayed when the compressor IPM fault error has occurred.	
		Comp location detection error	The error code is displayed when the compressor location detection failed.	Check the compressor wire connections. Check the soldering status of the inverter PCB. (Check if any parts have short-circuited). Check the Comp and Cycle.
		Comp motor constraint error	The error code is displayed when the compressor motor is constrained.	Check if the compressor and the Cycle is normal. Check the input voltage. Check the soldering of the inverter PCB. (Check if any parts have short-circuited.)
		Comp low voltage error	The error code is displayed when the AC Input Voltage is too low.	Check the input voltage. (This error occurs when the input voltage is AC 106 V or lower.)
		Comp over voltage error	The error code is displayed when the AC Input Voltage is too high.	Check the input voltage. (This error occurs when the input voltage is AC 310V or higher.)



## 4. TROUBLESHOOTING

### 4-1-3) Load Status Display Function

- 1) During the Normal Operation, press the Freezer + Fridge buttons for 7 seconds.  
Then, the "2°C, 3°C and 5°C" Fridge temperature LEDs and the "-17°C, -19°C and -21°C" Freezer temperature LEDs on the Display Panel will blink at the interval of 0.5 seconds for 3 seconds.
- 2) At this time, release the Freezer + Fridge buttons and press the Fridge button (it sends out "Ding Dong" sound.) Then, it shifts to the Load Display mode.
- 3) The Load Display function shows what MICOM signals come out from MAIN PCB.  
But, it just indicates that there are MICOM signals coming out.  
It does not necessarily mean that the related parts (Loads) are operating. In other word, even though it shows a certain load working, the related part may not operate due to such as a defective PCB relay or the defective part itself (it needs checking).
- 4) The Load Display function lasts for 30 seconds and then it goes back to the normal operation.
- 5) The following image shows load locations with the LEDs.

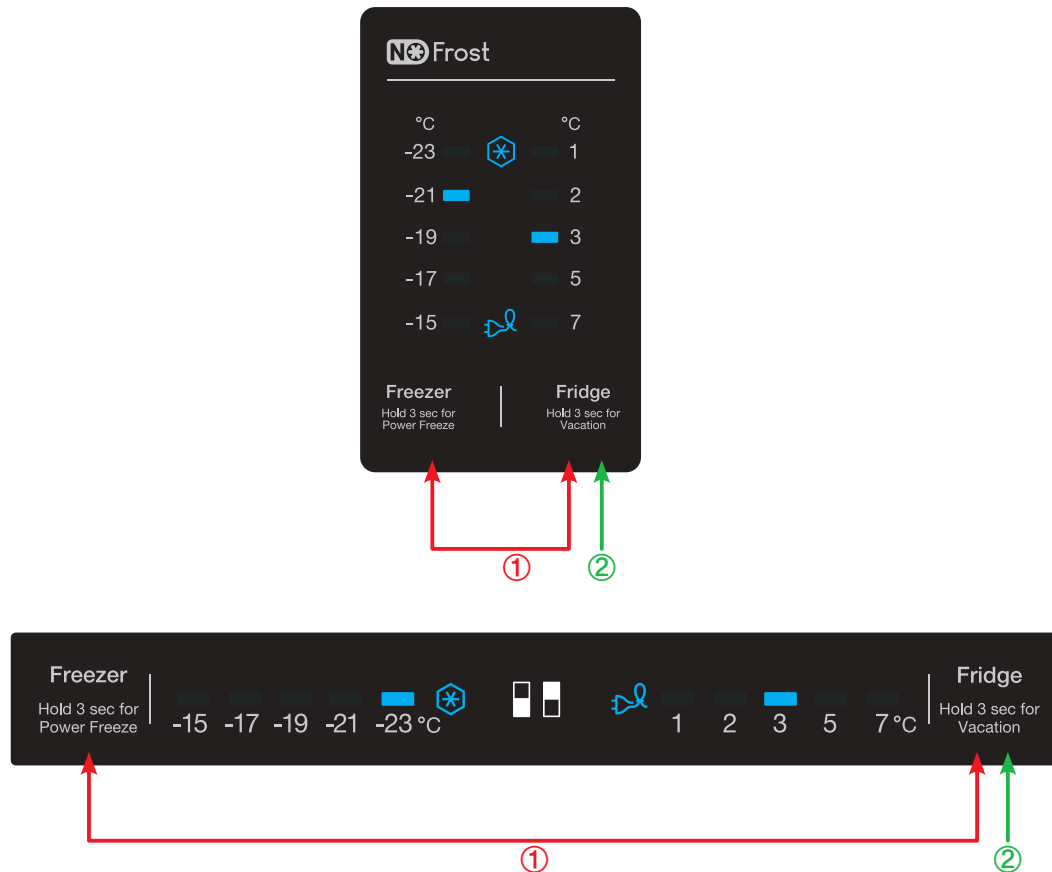

- ① Press the Freezer + Fridge buttons for 7 seconds at the same time.  
Then, the Display LEDs will blink for 3 seconds. At this time, release the buttons
- ② and, press the Fridge button once.

## 4. TROUBLESHOOTING

### ※ Load Mode Check List

NO	Category	Display LED	Description
1	COMP	Freezer "-23°C" Indicator LED On	LED On when Comp is running
2	F-Defrost HEATER	Freezer "-21°C" Indicator LED On	LED On when the Freezer Defrost Heater is on
3	R-Damper	Freezer "-19°C" Indicator LED On	LED On when the Fridge Damper is open.
4	Overload Conditions	Freezer "-17°C" Indicator LED On	LED On when the ambient temperature is over 34°C
5	Low Temperature Conditions	Freezer "-15°C" Indicator LED On	LED On when the ambient temperature is lower than 23°C
6	Demo Mode	Fridge "1°C" Indicator LED On	LED On when the unit is on Demo Mode
7	F-Fan High	Fridge "2°C" Indicator LED On	LED On when the F-Fan runs High
8	F-Fan Low	Fridge "3°C" Indicator LED On	LED On when the F-Fan runs Low
9	R-FAN High	Vacation" Indicator LED On	LED On When the R-Fan runs High
10	R-FAN Low	"Power Freezer" Indicator LED On	LED On When the R-Fan runs Low
11	C-Fan High	Fridge "5°C" Indicator LED On	LED On when the C-Fan runs High
12	C-Fan Low	Fridge "7°C" Indicator LED On	LED On when the C-Fan runs Low
13	Normal Operating Conditions	Freezer "-15°C","-17°C"LED Off	When the ambient temperature is between 24°C~33°C

## 4. TROUBLESHOOTING

### 4-1-4) Restoration of Previous Settings upon Instant Power Outage

- 1) If the Display Panel is initialized by the instant power outage, it will cause customer inquiries.  
To prevent this, when the power is restored, the previous settings will be restored or reset based on the inside temperature of the Freezer Compartment.
- 2) Upon the initial power on, it checks its Freezer temperature. When it is lower than +10°C, it is to be considered as an instant power failure and it brings back all its previous operation functions (such as Power Freeze, Vacation, Fridge, Freezer, Cool Select Zone, etc) related to the panel display.
- 3) When it is higher than +10°C, it is to be considered as a long-period power failure and it will initialize the panel display. (Freezer : Automatically set to -19°C → MID, Fridge : Automatically set to 3°C → MID)

### 4-1-5) Demo Mode Function for Store Display

- 1) During the Normal Operation, press the Freezer + Fridge buttons for 7 seconds.  
Then, the "2°C, 3°C and 5°C" Fridge temperature LEDs and the "-17°C, -19°C and -21°C" Freezer temperature LEDs on the Display Panel will blink at the interval of 0,5 seconds for 3 seconds.
- 2) At this time, release the Freezer + Fridge buttons and press the Freezer button (it sends out "Ding Dong" sound.) Then, it shifts to the Demo mode.
- 3) When the unit is in Demo Mode, all the functions including the Display Panel works normal. But, the Compressor does not operate.
- 4) To cancel the Demo Mode, press the same buttons for 7 seconds as you enter into the Demo Mode or turn off its power.
- 5) Also, when the Freezer or Fridge room temperature goes over 65°C during the Demo Mode, it will go back to the normal cooling operation.

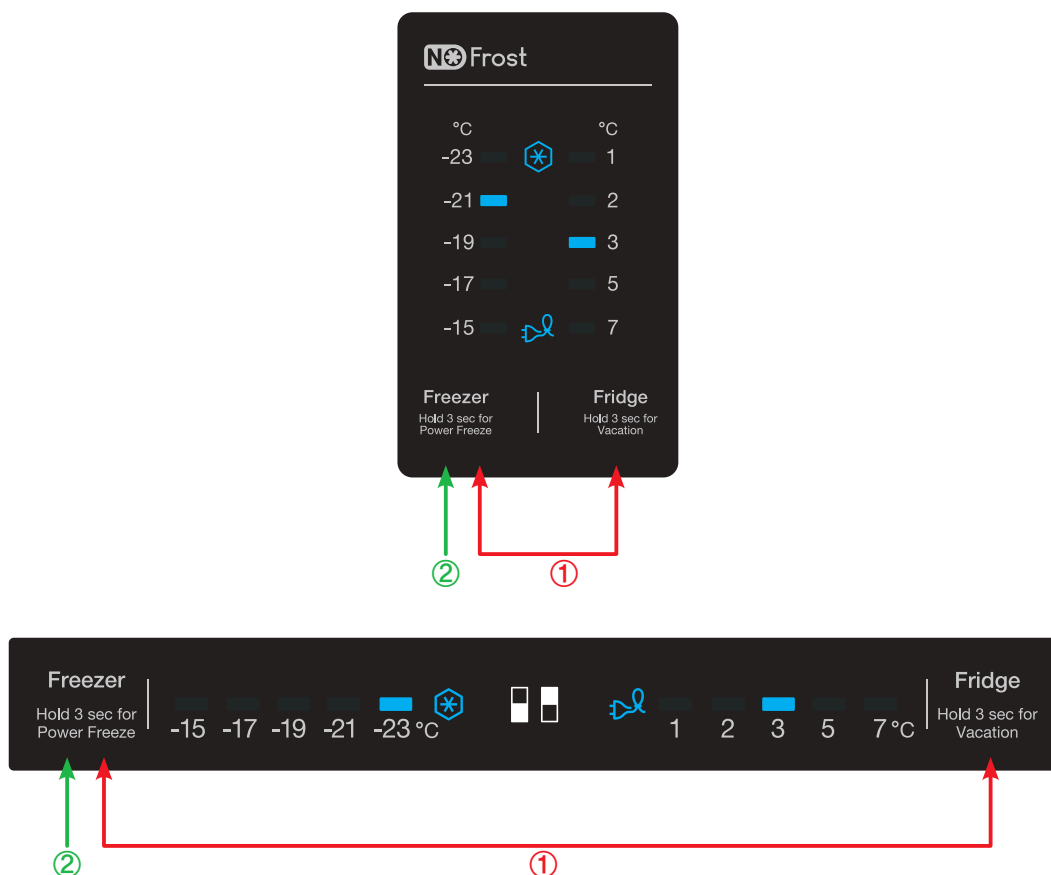

- ① Press the Freezer + Fridge buttons for 7 seconds at the same time.  
Then, the Display LEDs will blink for 3 seconds. At this time, release the buttons
- ② and, press the Freezer button once.

## 4. TROUBLESHOOTING

### 4-1-6) Option Setting Function

- 1) During the Normal Operation, press the Freezer + Fridge buttons for 4 seconds.  
Then, the entire Display Panel will blink at the interval of 0.5 seconds for 3 seconds.
  - 2) At this time, release the Freezer + Fridge buttons and press the Fridge button (it sends out "Ding Dong" sound.) Then, it shifts to the Option Setting mode.
- When there is no button press for 20 seconds at the Option Setting Mode, it will go back to the normal display mode.

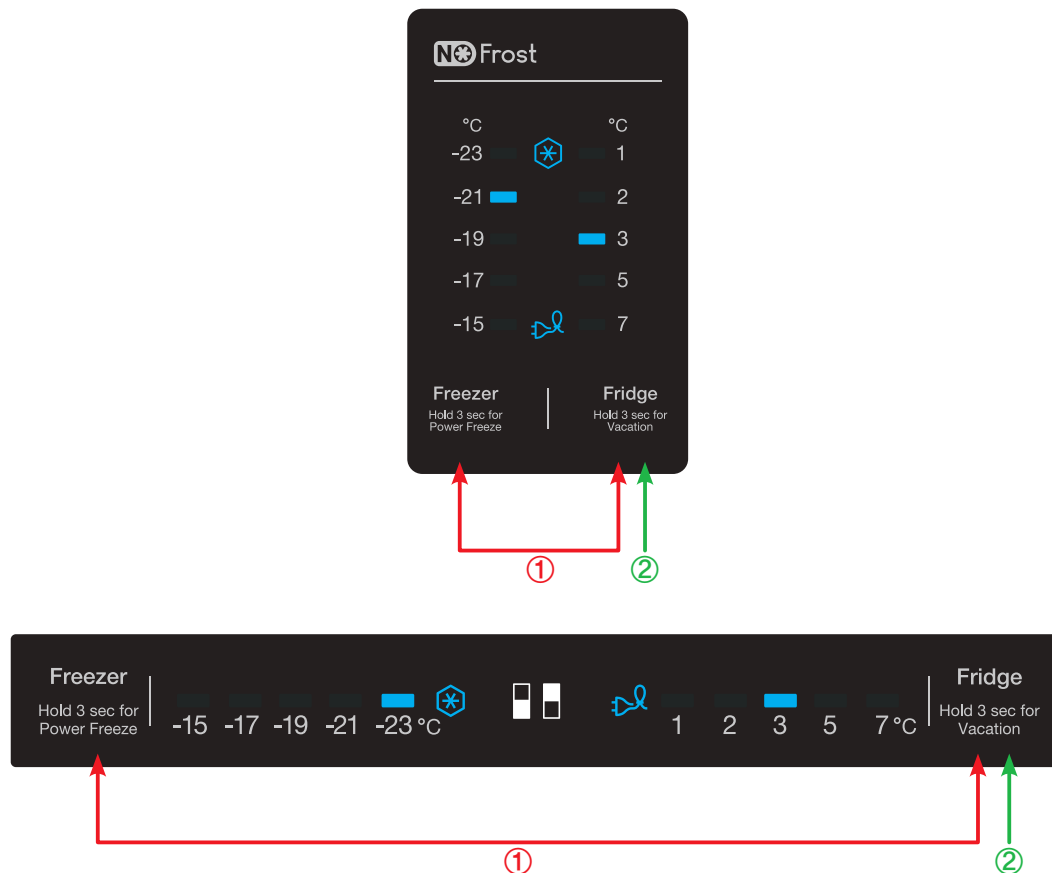

- ① Press the Freezer + Fridge buttons for 4 seconds at the same time.  
Then, the Display LEDs will blink for 3 seconds. At this time, release the buttons
- ② and, press the Fridge button once.

# 4. TROUBLESHOOTING

## Option Mode & Button Operation Description

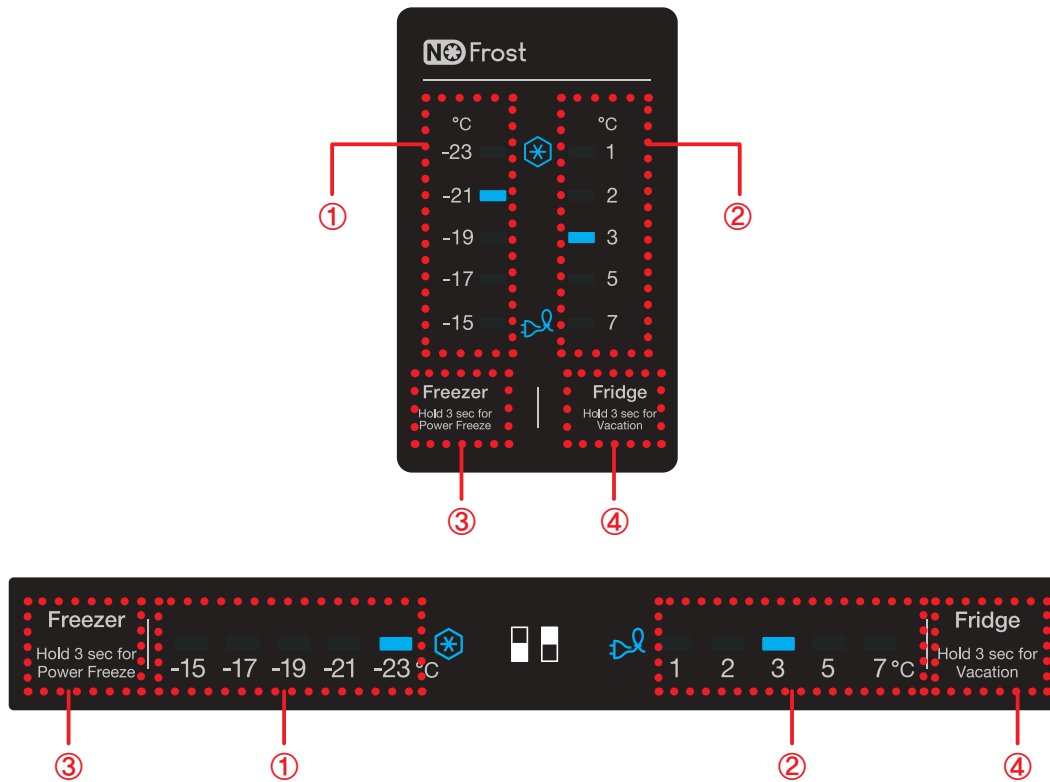

- ① Displays the selected Option Set Value
- ② Displays the selected Option #
- ③ OPTION SET VALUE INCREASE BY ONE DEGREE (Rotation Type)
- ④ OPTION # INCREASE BY ONE DEGREE (Rotation Type)

● The Bar Type Display Panel shows the numbers as shown in the following tables (Binary Type)

Value		0	1	2	3	4	5	6	7	8	9	10	11	12	13	14	15
F	R																
-23°C	1°C	□	□	□	□	□	□	□	□	□	□	□	□	□	□	□	□
-21°C	2°C	□	□	□	□	□	□	□	□	■	■	■	■	■	■	■	■
-19°C	3°C	□	□	□	□	■	■	■	■	□	□	□	□	■	■	■	■
-17°C	5°C	□	□	■	■	□	□	■	■	□	□	■	■	□	□	■	■
-15°C	7°C	□	■	□	■	□	■	□	■	□	■	□	■	□	■	□	■

Value		16	17	18	19	20	21	22	23	24	25	26	27	28	29	30	31
F	R																
-23°C	1°C	■	■	■	■	■	■	■	■	■	■	■	■	■	■	■	■
-21°C	2°C	□	□	□	□	□	□	□	□	■	■	■	■	■	■	■	■
-19°C	3°C	□	□	□	□	■	■	■	■	□	□	□	□	■	■	■	■
-17°C	5°C	□	□	■	■	□	□	■	■	□	□	■	■	□	□	■	■
-15°C	7°C	□	■	□	■	□	■	□	■	□	■	□	■	□	■	□	■

## 4. TROUBLESHOOTING

- When the Display Panel converts to the Option Setting mode, the entire Display except the Freezer and the Fridge Temperature LEDs as shown below Temp LED goes off.



- For example, if you want to shift the standard temp of the Freezer compartment by  $-2^{\circ}\text{C}$ , follow the steps below. This function is to change the default temperature and when the default temperature of the Freezer compartment is  $-21^{\circ}\text{C}$  and the default setting is lowered by  $-2^{\circ}\text{C}$  with the Option function, the default temperature will be controlled at  $-23^{\circ}\text{C}$ . That is, when changing temperature options, the Freezer compartment will operate at  $-23^{\circ}\text{C}$  internally even if it shows  $-21^{\circ}\text{C}$  on the display panel. Therefore, the temperature will be controlled by  $-2^{\circ}\text{C}$  lower than the set temperature on the display panel.

**Note** Basically, when units being shipped out, all the data in the Option function are cleared. That is, the Default settings are "0". However, for the purpose of quality improvement during mass production, the Default values may change. Therefore, be sure to check quality information, such as SVC bulletins.

- After changing into the Option mode, "0" on both of the Fridge and Freezer compartments lights up on the display panel. (when units being shipped out, the unit will be shipped out with "0"s set on both of the Fridge and Freezer compartments. However, for the purpose of quality improvement during mass production, the Default values may change.)

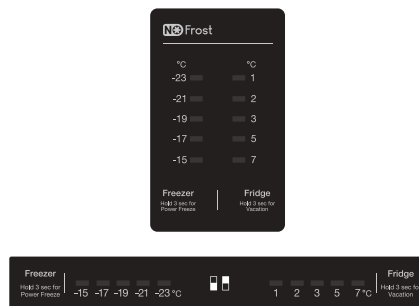

- When the Fridge Display set to the status of the Option #0, it will be set to the Freezer Temperature Option and the current Freezer Temperature Set Value will be shown on the Freezer Temperature Display (Refer to the Freezer Temp Shifting Image).
- When "4" is set as shown in the Freezer Option Table below after setting the Fridge Option # to "0", the Freezer default temperature will decrease by  $-2^{\circ}\text{C}$ . (Refer to the Freezer Temp Shift Figure)  
:In 20 seconds after completing the adjustment, MICOM is to store the setting value in EEPROM and it goes back to the normal display mode, deactivating the Option Setting mode.
  - The Fridge temperature can be adjusted with the same method.
  - Make sure not to change the factory-set default values excluding exceptional circumstances. Also, the Option Setting will be completed when it goes back to the normal display mode in 20 seconds. So, do not turn off the unit before it goes back to the normal display mode.

# 4. TROUBLESHOOTING

## 4-1-7) Option Table

**Note** There are other option setting functions. But, it's got to do with the performance of the unit, not for repair purposes. So, they are not handled in this manual.  
(Except those described in this manual, do not change other values)

### 1) Freezer Temp Shift Table

Setting Item	Freezer Temp Shift
Option Item	Location : Fridge Temp LED
	0

Setting Value	Option Value
Freezer Temp Display Panel Set Value	
0	0
1	-0.5°C
2	-1.0°C
3	-1.5°C
4	-2.0°C
5	-2.5°C
6	-3.0°C
7	-3.5°C
8	+0.5°C
9	+1.0°C
10	+1.5°C
11	+2.0°C
12	+2.5°C
13	+3.0°C
14	+3.5°C
15	+4.0°C

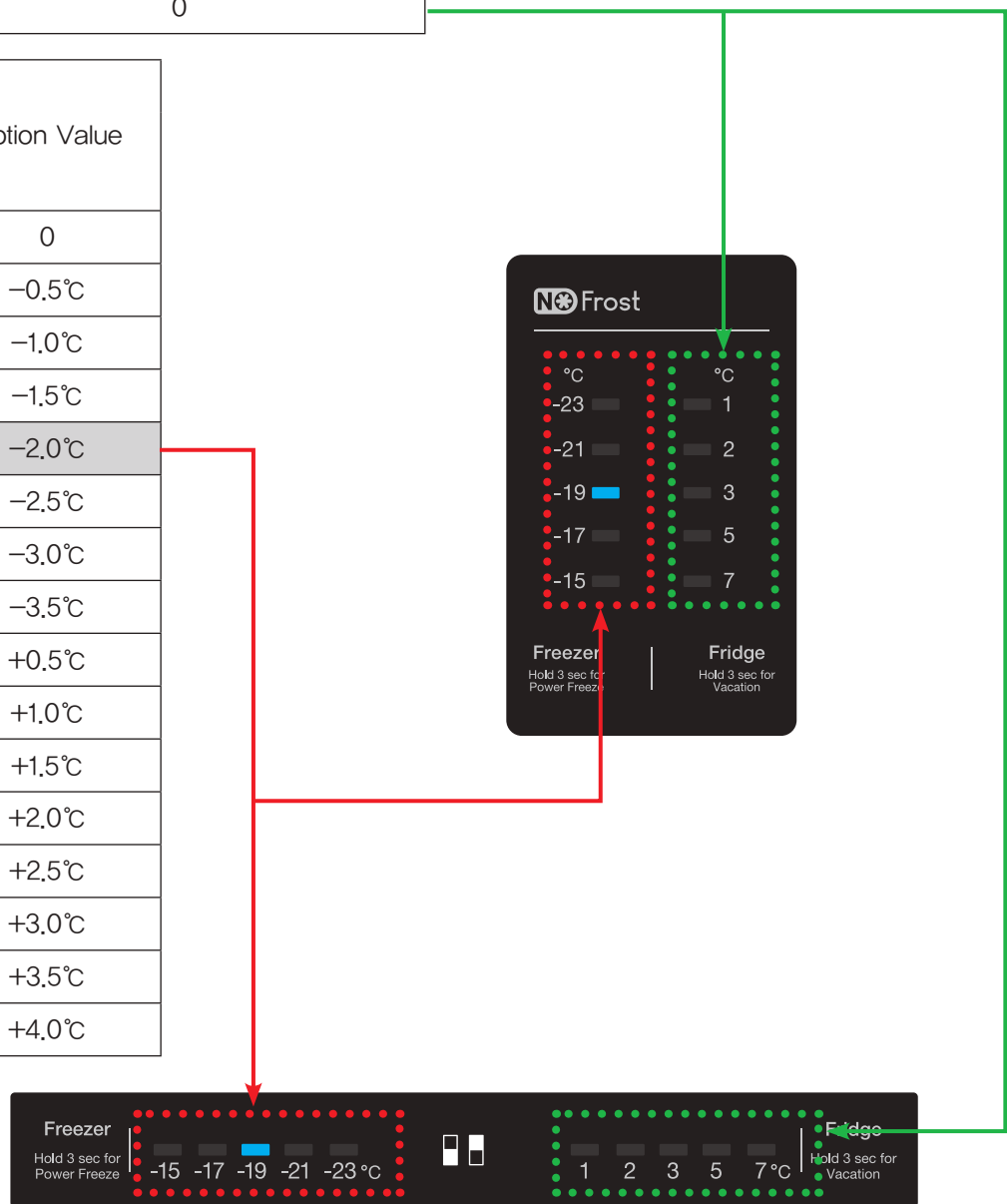

Ex) When shifting the Freezer default temp by -2.0°C

# 4. TROUBLESHOOTING

## 2) Fridge Temp Shift Table

Setting Item	Fridge Temp Shift
Option Item	Location : Fridge Temp Display
	1

Setting Value	Option Value
Fridge Temp Display Panel Set Value	
0	0
1	-0.5°C
2	-1.0°C
3	-1.5°C
4	-2.0°C
5	-2.5°C
6	-3.0°C
7	-3.5°C
8	+0.5°C
9	+1.0°C
10	+1.5°C
11	+2.0°C
12	+2.5°C
13	+3.0°C
14	+3.5°C
15	+4.0°C

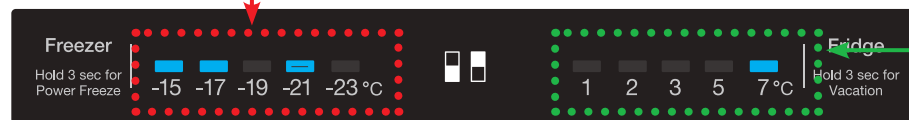
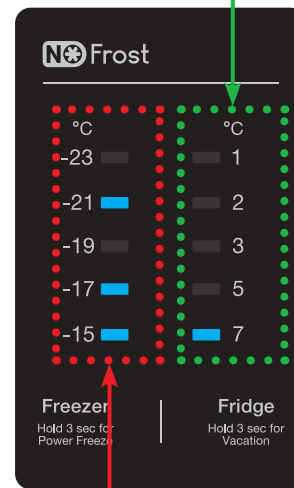

Ex) When shifting the Fridge default temp by +2.0°C



# 4. TROUBLESHOOTING

## 2) Fridge Temp Shift Table

Setting Item	Display Off Option
Option Item	Location : Fridge Temp Display
	16

Setting Value	Option Value
Fridge Temp Display Panel Set Value	Option Value
0	Display Off in 10 seconds after feeding the Key value
1	Display On mode persists
2	Display On mode persists

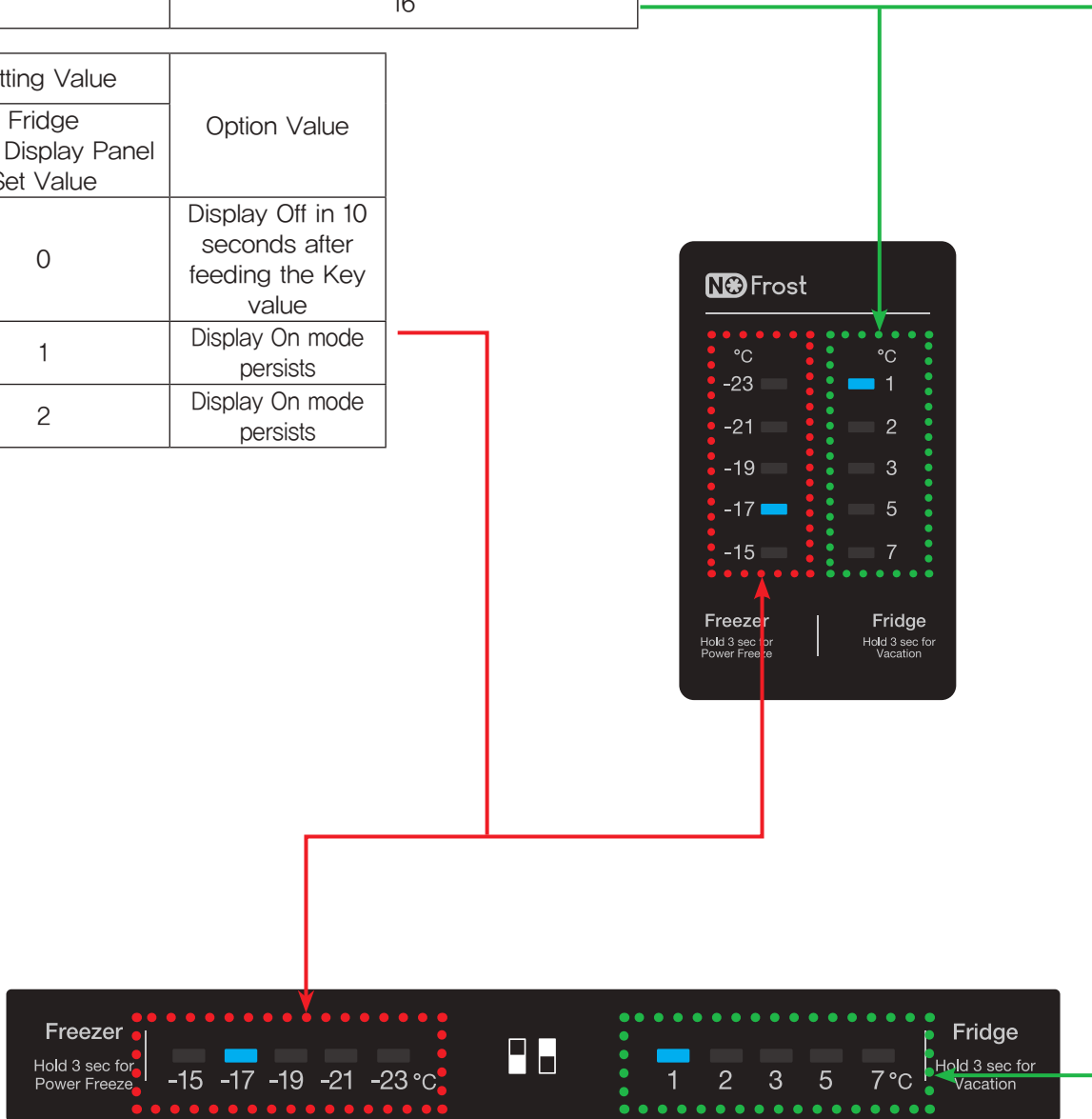

Ex) When set Fridge Value "2"

## 4. TROUBLESHOOTING

### 4-2) Troubleshooting Flow-Chart by Symptoms

4-2-1) Troubleshooting for Self-Diagnosis Errors . . . . .	60
4-2-2) When the Freezer Fan does not operate (BLDC Motor) . . . . .	65
4-2-3) When the C-Fan does not operate (BLDC Motor) . . . . .	66
4-2-4) When Defrost does not work (F DEF Heater) . . . . .	67
4-2-5) When the unit does not turn on (INVERTER PCB) . . . . .	68
4-2-6) When there is No Power (INVERTER PBA) A+++ . . . . .	69
4-2-7) When the Compressor is not working (INVERTER PBA) . . . . .	70
4-2-8) When the Compressor is not working (INVERTER PBA) A+++ . . . . .	71
4-2-9) When the unit keeps alarming (Buzzer Sound) . . . . .	72
4-2-10) When PANEL PCB operates abnormally . . . . .	74
4-2-11) When the Room Lamp (LED) does not light up . . . . .	75
4-2-12) When Fridge Damper does not work . . . . .	76
4-2-13) When Cool Select Zone Damper does not work (Applies only to models with CSZ) . . . . .	77
4-2-14) LED blinking frequency depending on protecting functions (Inverter PBA) . . . . .	78

# 4. TROUBLESHOOTING

## 4-2) Troubleshooting Flow-Chart by Symptoms

DATA1.Temp Table

Conversion Table – Temperature/MICOM PORT Voltage/Resistance

SENSOR CHIP : PX41C

°C	°F	Voltage	Ω	°C	°F	Voltage	Ω	°C	°F	Voltage	Ω
-50	-58	4.694	153319	-5	23	3.107	16419	40	104	1.153	2997
-49	-56.2	4.677	144794	-4	24.8	3.057	15731	41	105.8	1.124	2899
-48	-54.4	4.659	136798	-3	26.6	3.006	15076	42	107.6	1.095	2805
-47	-52.6	4.641	129294	-2	28.4	2.955	14452	43	109.4	1.068	2714
-46	-50.8	4.622	122248	-1	30.2	2.904	13857	44	111.2	1.040	2627
-45	-49	4.602	115631	0	32	2.853	13290	45	113	1.014	2543
-44	-47.2	4.581	109413	1	33.8	2.802	12749	46	114.8	0.988	2462
-43	-45.4	4.560	103569	2	35.6	2.751	12233	47	116.6	0.963	2384
-42	-43.6	4.537	98073	3	37.4	2.700	11741	48	118.4	0.938	2309
-41	-41.8	4.514	92903	4	39.2	2.649	11271	49	120.2	0.914	2237
-40	-40	4.490	88037	5	41	2.599	10823	50	122	0.891	2167
-39	-38.2	4.465	83456	6	42.8	2.548	10395	51	123.8	0.868	2100
-38	-36.4	4.439	79142	7	44.6	2.498	9986	52	125.6	0.846	2036
-37	-34.6	4.412	75077	8	46.4	2.449	9596	53	127.4	0.824	1973
-36	-32.8	4.385	71246	9	48.2	2.399	9223	54	129.2	0.803	1913
-35	-31	4.356	67634	10	50	2.350	8867	55	131	0.783	1855
-34	-29.2	4.326	64227	11	51.8	2.301	8526	56	132.8	0.762	1799
-33	-27.4	4.296	61012	12	53.6	2.253	8200	57	134.6	0.743	1745
-32	-25.6	4.264	57977	13	55.4	2.205	7888	58	136.4	0.724	1693
-31	-23.8	4.232	55112	14	57.2	2.158	7590	59	138.2	0.706	1642
-30	-22	4.199	52406	15	59	2.111	7305	60	140	0.688	1594
-29	-20.2	4.165	49848	16	60.8	2.064	7032	61	141.8	0.670	1547
-28	-18.4	4.129	47431	17	62.6	2.019	6771	62	143.6	0.653	1502
-27	-16.6	4.093	45146	18	64.4	1.974	6521	63	145.4	0.636	1458
-26	-14.8	4.056	42984	19	66.2	1.929	6281	64	147.2	0.620	1416
-25	-13	4.018	40938	20	68	1.885	6052	65	149	0.604	1375
-24	-11.2	3.980	39002	21	69.8	1.842	5832	66	150.8	0.589	1335
-23	-9.4	3.940	37169	22	71.6	1.799	5621	67	152.6	0.574	1297
-22	-7.6	3.899	35433	23	73.4	1.757	5419	68	154.4	0.560	1260
-21	-5.8	3.858	33788	24	75.2	1.716	5225	69	156.2	0.546	1225
-20	-4	3.816	32230	25	77	1.675	5039	70	158	0.532	1190
-19	-2.2	3.773	30752	26	78.8	1.636	4861	71	159.8	0.519	1157
-18	-0.4	3.729	29350	27	80.6	1.596	4690	72	161.6	0.506	1125
-17	1.4	3.685	28021	28	82.4	1.558	4526	73	163.4	0.493	1093
-16	3.2	3.640	26760	29	84.2	1.520	4369	74	165.2	0.481	1063
-15	5	3.594	25562	30	86	1.483	4218	75	167	0.469	1034
-14	6.8	3.548	24425	31	87.8	1.447	4072	76	168.8	0.457	1006
-13	8.6	3.501	23345	32	89.6	1.412	3933	77	170.6	0.446	978
-12	10.4	3.453	22320	33	91.4	1.377	3799	78	172.4	0.435	952
-11	12.2	3.405	21345	34	93.2	1.343	3670	79	174.2	0.424	926
-10	14	3.356	20418	35	95	1.309	3547	80	176	0.414	902
-9	15.8	3.307	19537	36	96.8	1.277	3428	81	177.8	0.404	877
-8	17.6	3.258	18698	37	98.6	1.253	3344	82	179.6	0.394	854
-7	19.4	3.208	17901	38	100.4	1.213	3204	83	181.4	0.384	832
-6	21.2	3.158	17142	39	102.2	1.183	3098	84	183.2	0.375	810

# 4. TROUBLESHOOTING

## 4-2-1) When Self-Diagnosis Error occurs

- The Display Panel shows the Sensor Error and, when the unit is plugged in and there are sensor errors, the unit does not operate and LED related to the defective sensors keep blinking.
- When sensor defects occur during the operation, the unit keeps working. But, it shifts to the Emergency Operation and it may not work properly. So, please check the unit according to the Self Diagnosis function.

### 1) When the R-Sensor is defective

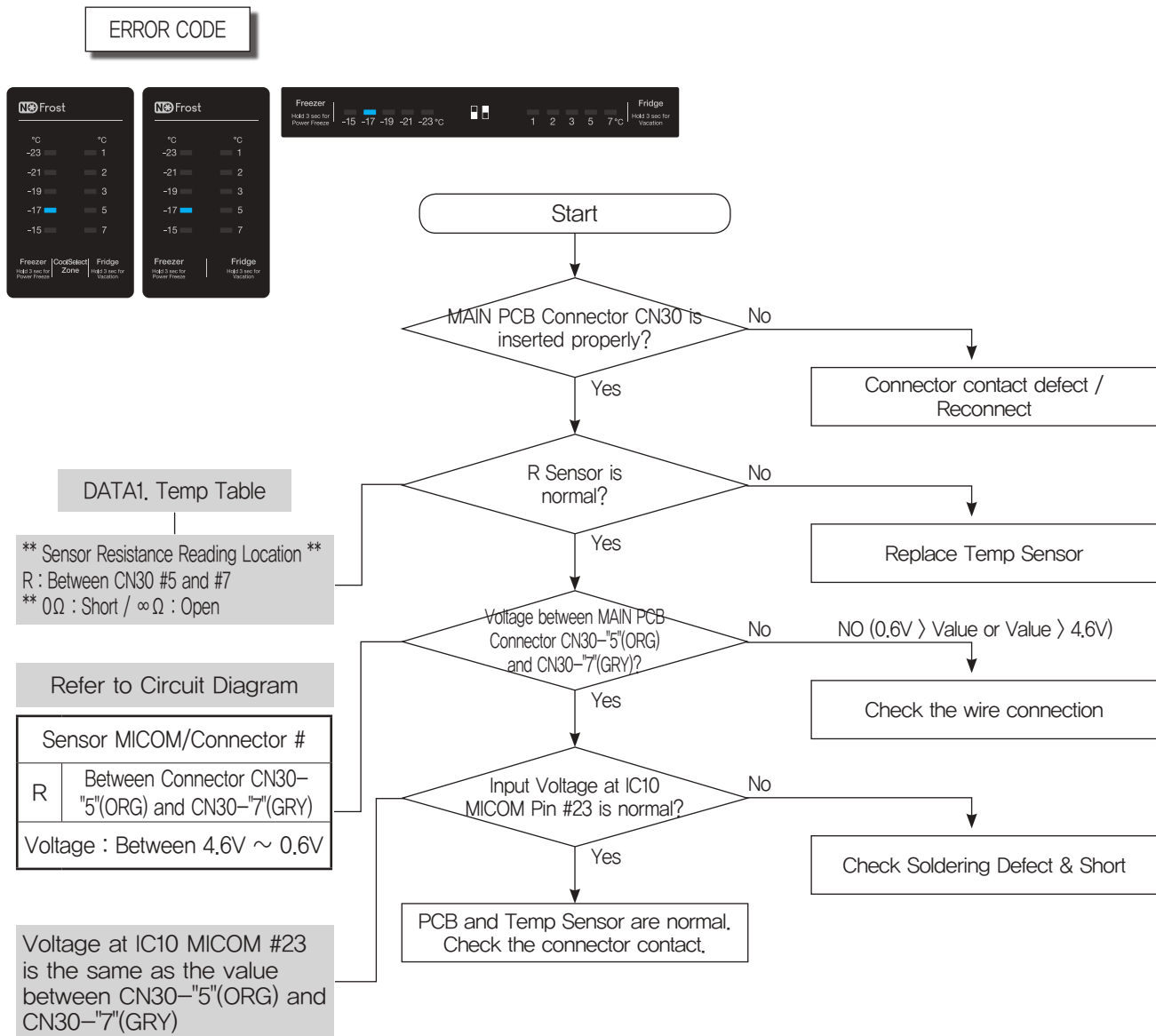

# 4. TROUBLESHOOTING

## 2) When the EXT Sensor is defective

ERROR CODE

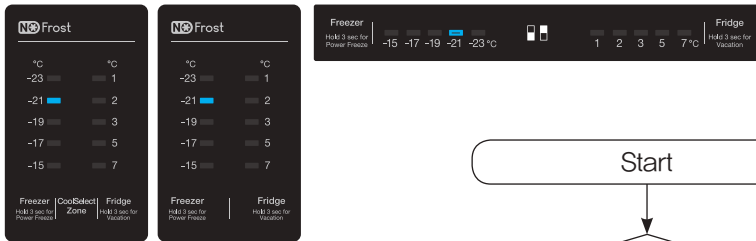

DATA1. Temp Table

**\*\* Sensor Resistance Reading Location \*\***  
 Ambient : Between CN31-#1 and #2.  
**\*\* Located in the PCB Box**  
**\*\* 0Ω : Short / ∞Ω : Open**

Refer to Circuit Diagram

Sensor MICOM/Connector #	
Ambient	Between Connector CN31- "1"(WHT) and CN31- "2"(WHT)
Voltage : Between 4.6V ~ 0.6V	

Voltage at IC10 MICOM #21 is the same as the value between CN31-"1"(WHT) and CN31-"2"(WHT) of the CN31 on MAIN PBA.

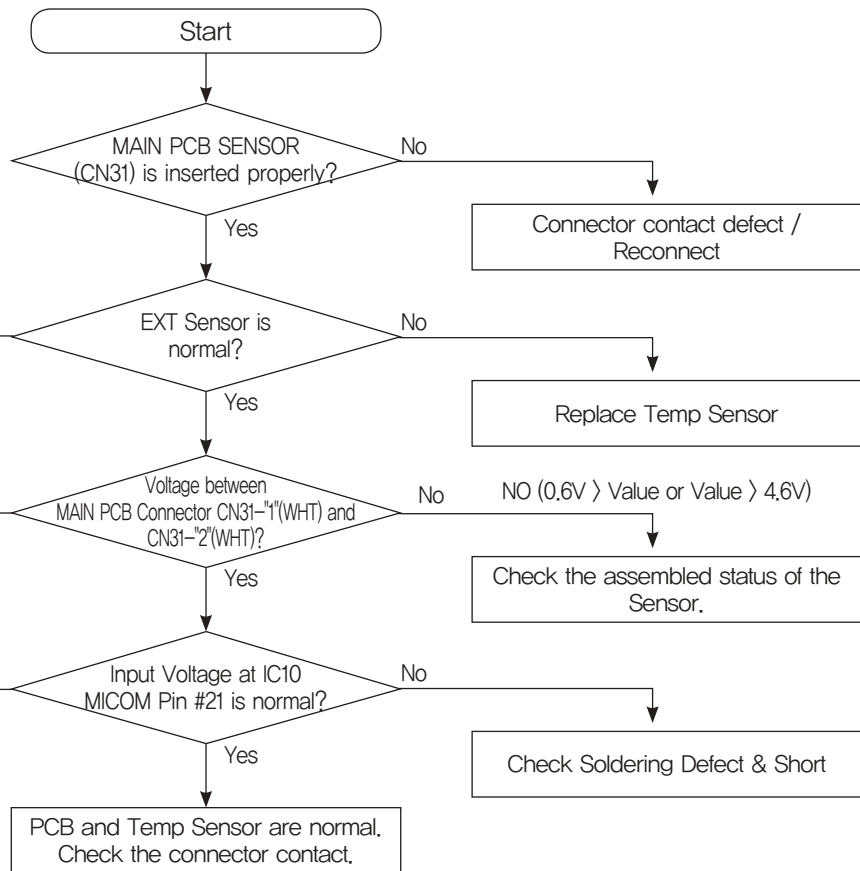

# 4. TROUBLESHOOTING

## 3) When the F-Sensor is defective

ERROR CODE

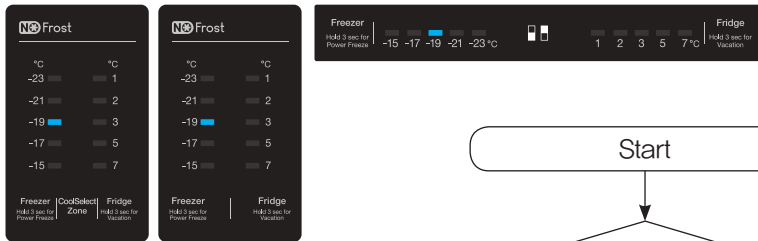

\*\* Sensor Resistance Reading Location \*\*  
 F : Between CN30 #3 and #7  
 \*\* 0Ω : Short / ∞Ω : Open

Refer to Circuit Diagram

Sensor MICOM/Connector #	
F	Between Connector CN30- "3"(BRN) and CN30-"7"(GRY)
Voltage : Between 4.6V ~ 0.6V	

Voltage at IC10 MICOM #  
 25 is the same as the value  
 between CN30-"3"(BRN) and  
 CN30-"7"(GRY)

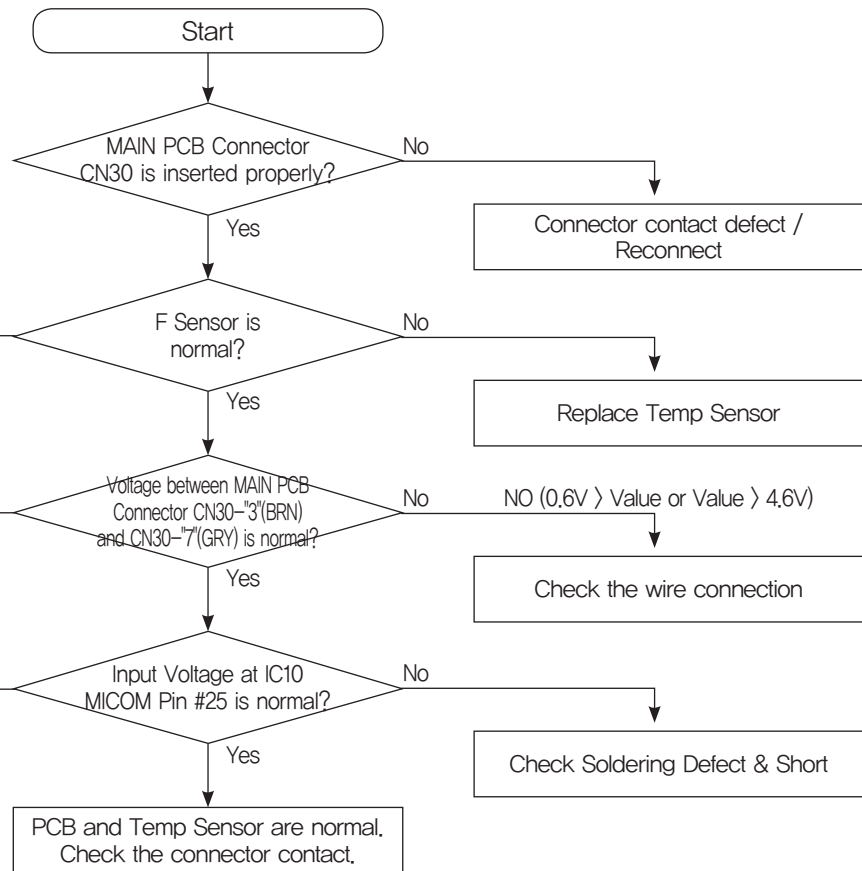

# 4. TROUBLESHOOTING

## 4) When the DEF-Sensor is defective

ERROR CODE

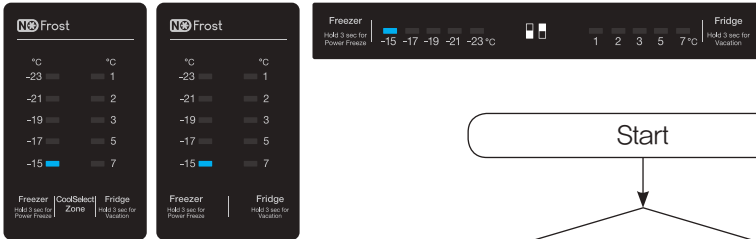

DATA1. Temp Table

\*\* Sensor Resistance Reading Location \*\*  
 F-DEF : Between CN30 #4 and #7  
 \*\* 0.Ω : Short / ∞Ω : Open

Refer to Circuit Diagram

Sensor MICOM/Connector #	
F DEF	Between Connector CN30-"4"(RED) and CN30-"7"(GRY)
Voltage : Between 4.6V ~ 0.6V	

Voltage at IC10 MICOM # 24 is the same as the value between CN30-"4"(RED) and CN30-"7"(GRY).

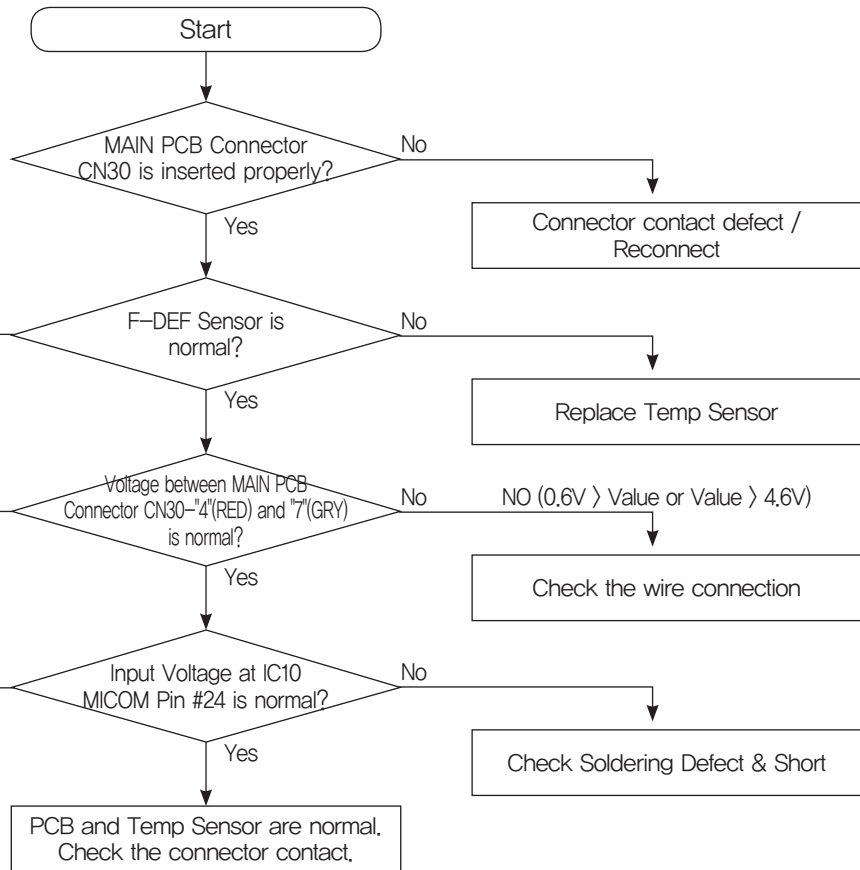

# 4. TROUBLESHOOTING

## 5) When the Cool Select Zone sensor is defective (CSZ models only)

ERROR CODE

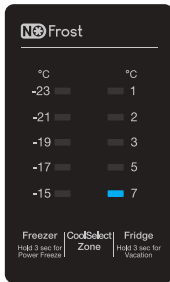

DATA1. Temp Table

\*\* Sensor Resistance Reading Location \*\*  
 CSZ : Between CN30 #2 and #7  
 \*\* 0Ω : Short / ∞Ω : Open

Refer to Circuit Diagram

Sensor MICOM/Connector #	
F DEF	Between Connector CN30- "2"(BLK) and CN30- "7"(GRY)
Voltage : Between 4.6V ~ 0.6V	

Voltage at IC10 MICOM #  
 26 is the same as the value  
 between CN30-"2"(BLK) and  
 CN30-"7"(GRY).

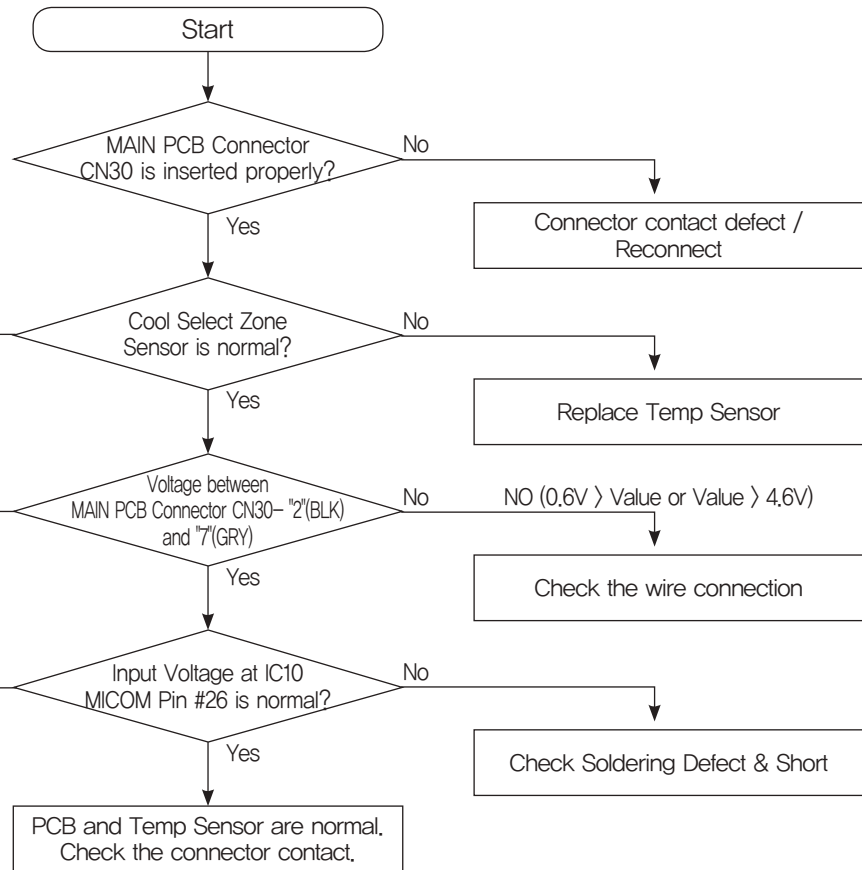



# 4. TROUBLESHOOTING

## 4-2-2) When the Freezer Fan does not operate (BLDC Motor)

- This refrigerator uses the BLDC Fan Motor.  
The BLDC Motor operates with DC 7~12V.
- The F-Fan motor generally runs together with the compressor.

☞ When checking with the Self Diagnosis

F FAN ERROR

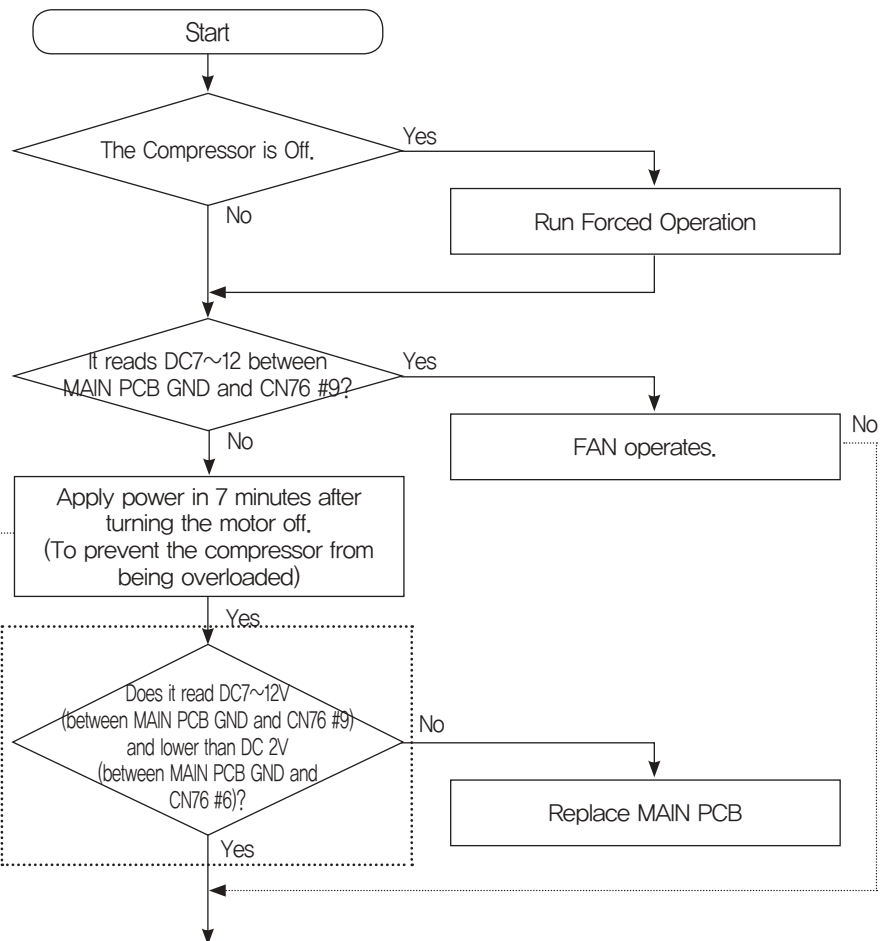
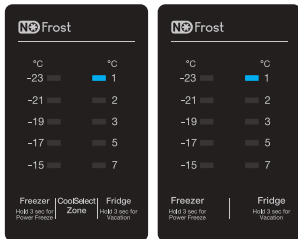

Upon the initial power on, the compressor and the F-Fan operate. And, when the Freezer temp is lower than 10°C, it will be regarded as an instant power failure, starting in 7 minutes.

- ◆ Possible Causes
  - ① Defective FAN-MOTOR
  - ② Contact problem at the terminal (MAIN PCB CONNECTOR-TERMINAL (CN76. ⑥, ⑨, ⑩), Contact problem at Freezer Fan Motor Connector, Defective Motor Wire)
  - ③ Check the motor rotating pulse input upon Fan Motor operation, (Refer to Fan-Motor Circuit in this manual)

# 4. TROUBLESHOOTING

## 4-2-3) When the refrigerator(R) FAN does not work (restricted to R-FAN applied models only)

- This refrigerator uses BLDC FAN motor.  
BLDC motor operates by DC 7~12V.
- Generally, under COMP ON condition, FAN motor operates together.

☞ Content to be displayed when checking the self-diagnosis function



When first impressing the voltage the compressor and FAN work, but they start operating in 7 minutes after detecting the temperature (below 10°C in compartment F, compartment F defrosting) due to temporary power cut.

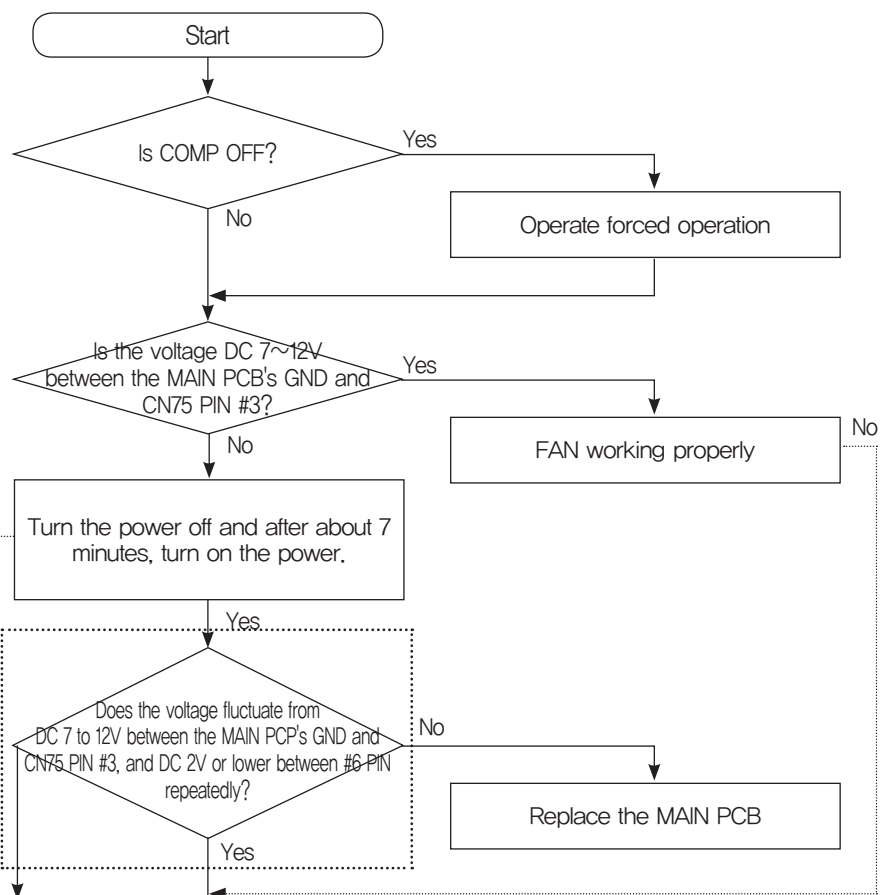

◆ Reference : Pulse signal that occurs when motor is spinning is input at CN75 PIN #6.  
This signal is input at MICOM and when the signal is not input when motor is running, turn off the fan and turn it back on after 10 seconds.  
If the signal still does not turn on, then repeat the process above 4 more times.  
If the signal still does not turn on, restart the motor after 10 minutes.  
This function is applied in case the motor restriction is caused by ice or any other foreign substances around the motor.

- ◆ Expected cause
- ① Faulty FAN-MOTOR
  - ② Check if there's faulty connection between wires.  
(MAIN PCB CONNECTOR – TERMINAL part (CN75.①, ③, ⑥) refrigerator FAN MONTOR connecting part's faulty contact, faulty MOTOR connecting WIRE)
  - ③ Check motor spinning pulse input during fan motor operation  
(Please refer to this manual's FAN-MOTOR driving circuit part)

# 4. TROUBLESHOOTING

## 4-2-4) When the C-Fan does not operate (Applies to Models with C-Fan)

- This refrigerator uses the BLDC Fan Motor.  
The BLDC Motor operates with DC 7~12V.
- The F-Fan motor generally runs together with the compressor.

☞ When checking with the Self Diagnosis

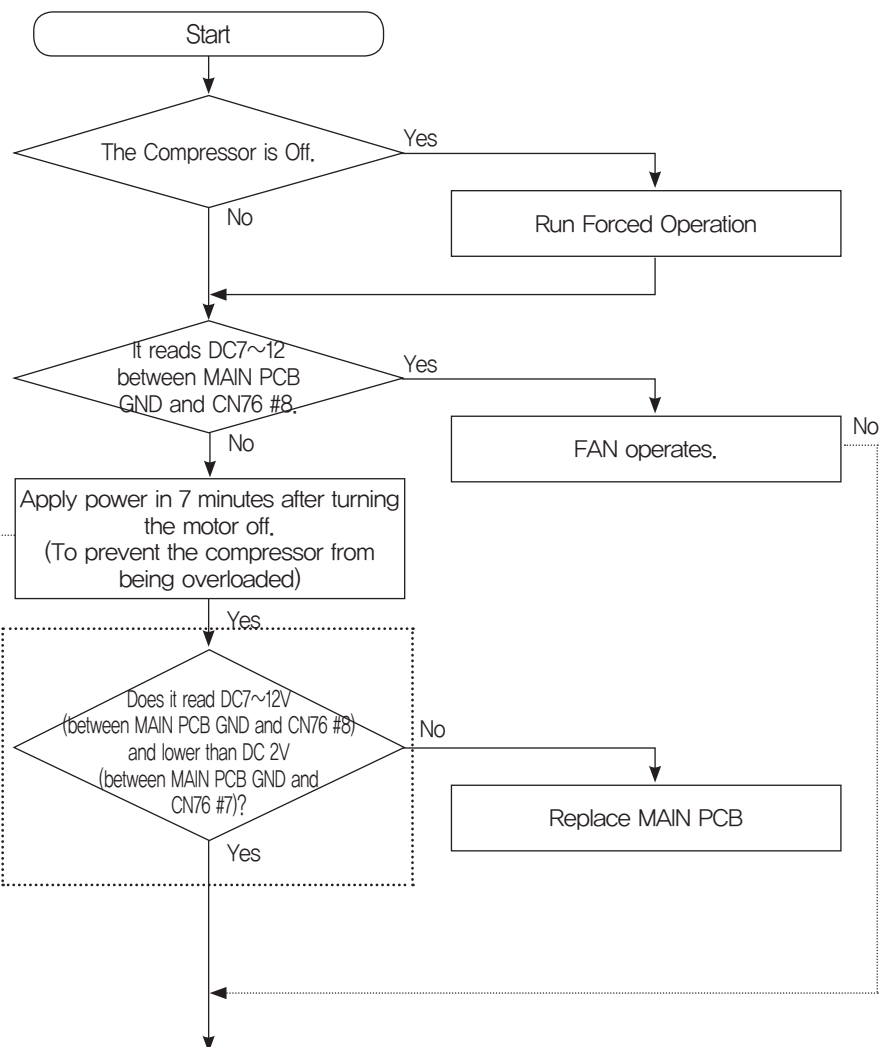
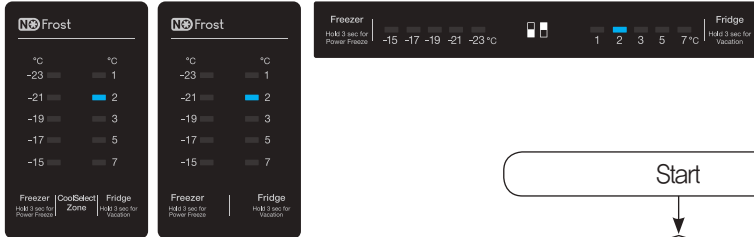

Upon the initial power on, the compressor and the C-Fan operate. And, this function starts operating when the compressor is about to run right after an instant power outage.

- ◆ Note : C-FAN Operations by Ambient Temperature
- 29°C or higher : Turns on after a 10 minute pause when the Compressor starts operating.
  - 18°C~28°C : Turns on immediately when the Compressor starts operating.
  - 18°C or higher : Turns off after a minute when the Compressor stops operating.
  - 17°C or lower : Turns on when the Compressor starts operating. (But, the C-FAN turns on when the C-FAN is detected as being restricted for an hour continually).
  - 17°C or lower : Turns off (for up to 150 minutes) when the Compressor stops operating.

- ◆ Possible Causes
- ① Defective FAN-MOTOR
  - ② Contact problem at the terminal (MAIN PCB CONNECTOR-TERMINAL (CN76. ⑦,⑧,⑩), Contact problem at C-Fan Motor Connector, Defective Motor Wire)
  - ③ Check the motor rotating pulse input upon Fan Motor operation, (Refer to Fan-Motor Circuit in this manual)

# 4. TROUBLESHOOTING

## 4-2-5) When Defrost does not work (F DEF Heater)

- When there is a trouble in defrosting, select the Self-Diagnosis function before turning off the unit. And, check if there is any defect in the Defrost Heater. If not, plug out the unit and do the Trouble-Shooting. (Refer to the Self-Diagnosis function and check the details)

☞ When checking with the Self Diagnosis

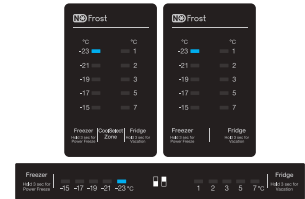

**\*\* Heater Resistance Reading Location \*\***  
 F-DEF : Resistance between CN70 #5 (BRN) ↔ CN77 #3 (ORG) should be 260 ohm ± 10%,  
**\*\* 0Ω : Short / ∞Ω : Open**  
 (Bimetal / Thermal Fuse / Heater Defect)

**\*\* Sensor Resistance Reading Location \*\***  
 F-DEF : Between CN30 #4 (RED) ↔ CN30 #7 (GRU)  
**\*\* 0Ω : Short / ∞Ω : Open**

30°C	4.22kΩ	For more detail data, refer to DATA1. Temp Table
20°C	6.05kΩ	
10°C	8.87kΩ	
0°C	13.29kΩ	
-10°C	20.42kΩ	
-20°C	32.23kΩ	
-30°C	52.41kΩ	

**\*\* Sensor Voltage Reading Location \*\***  
 F-DEF : Between PCB COMMON Ground and CN30 #4 (or SEN\_2)  
**\*\* 0V : Short / 5V : Open**

After pressing the Freezer and the Fridge buttons simultaneously for 4 seconds, push the Freezer button to enter the Test Mode. And then, when any one of the buttons is pressed twice, the Forced Defrost will start and the relevant LED Lamp will light up on the display panel.

Check the related sensors if they are defective.

**Note** When the temperature of the F DEF Sensor goes over 8°C with the Defrost Heater heating up, it stops heating and it goes back to Cooling Operation.

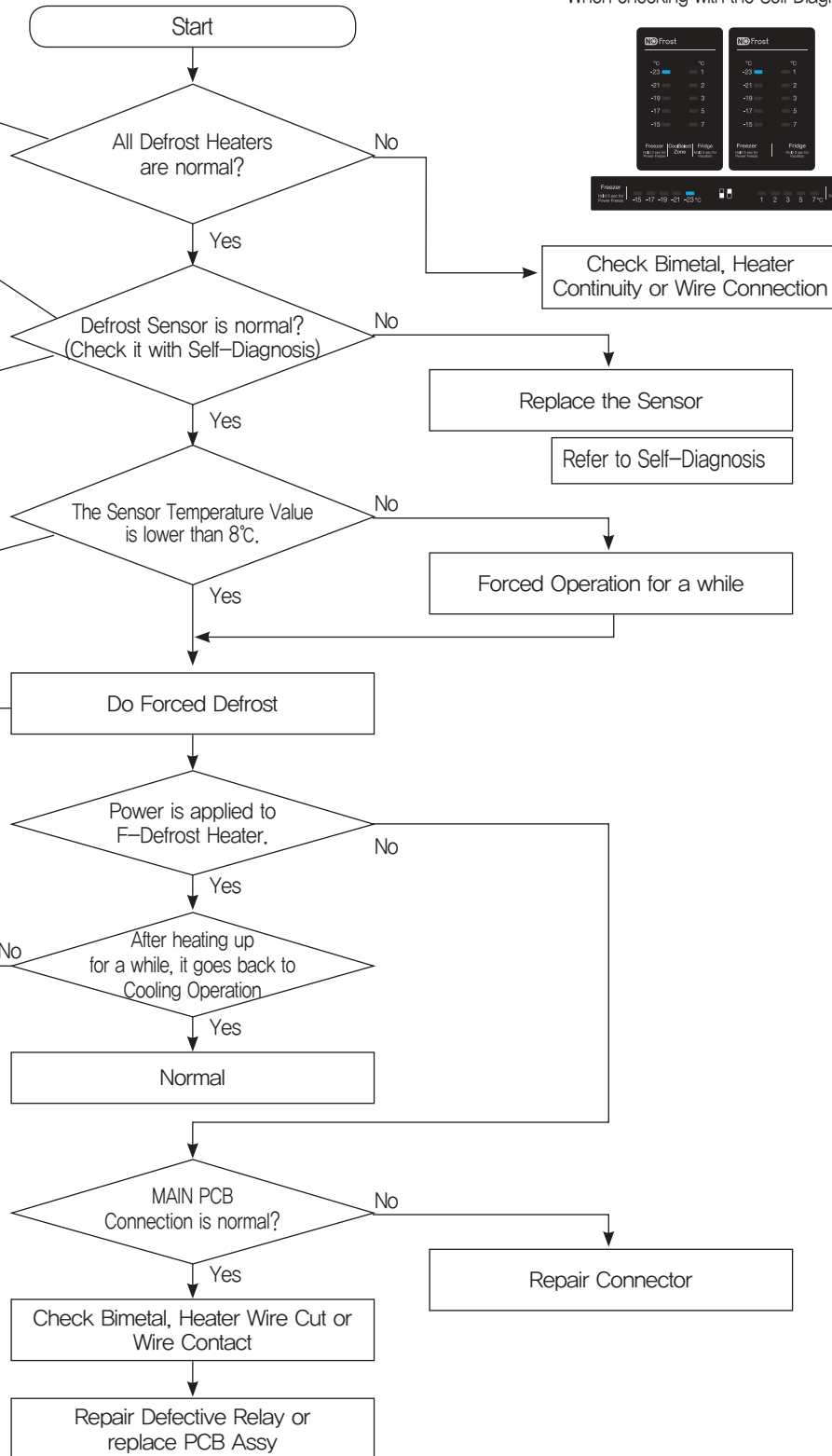

# 4. TROUBLESHOOTING

## 4-2-6) When there is No Power (MAIN PBA)

### Caution

There is AC220~240V or DC310~340V at the MAIN PCB Power Circuit. So, be cautious when repairing the unit or measuring values.

- When checking the MAIN PCB, refer to the Operation descriptions and the "Reference" section.

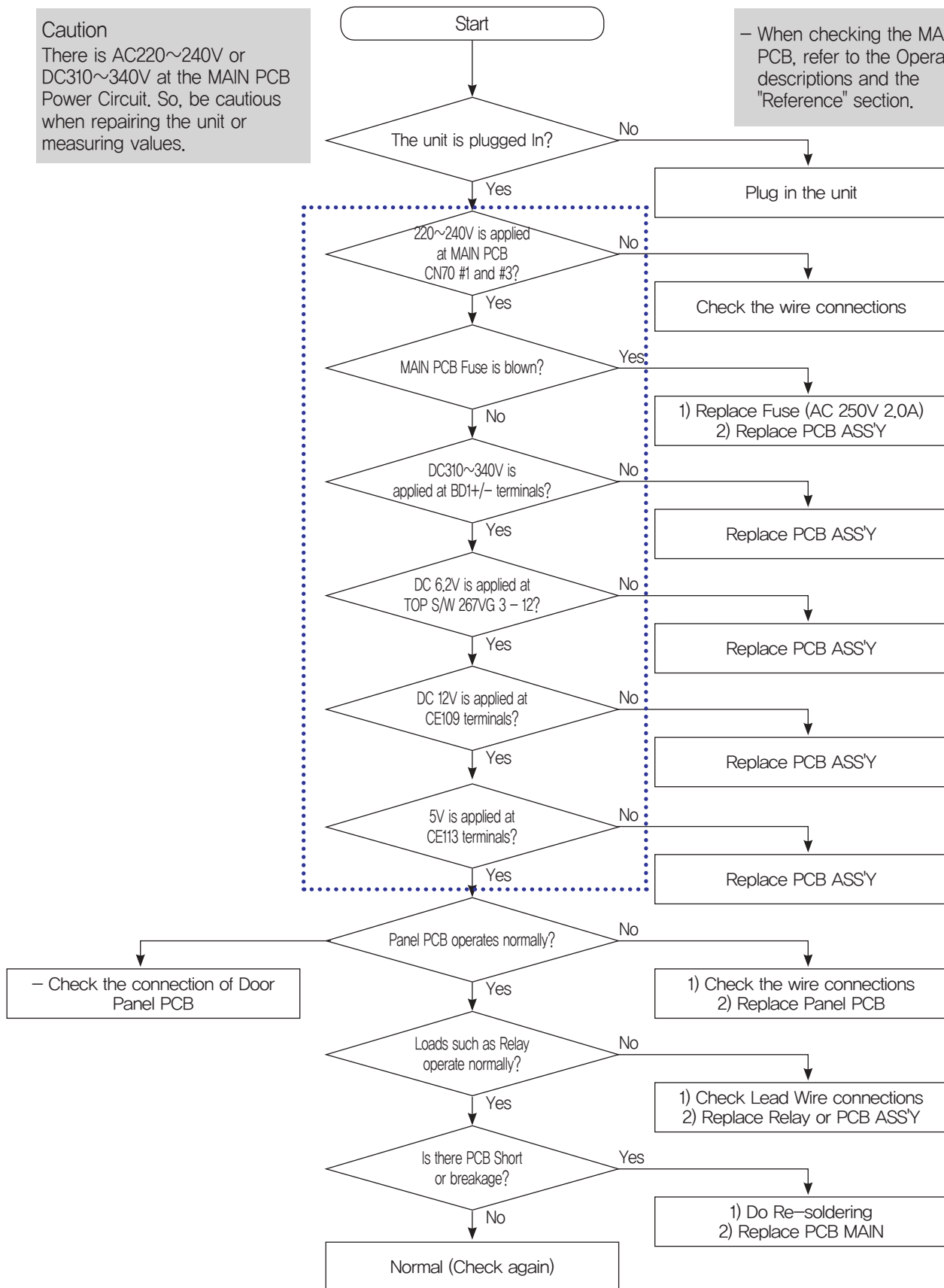

# 4. TROUBLESHOOTING

## 4-2-7) When there is No Power (INVERTER PBA) A+++

### Caution

There is AC230V or DC310V at the INVERTER PBA Power Circuit. So, be cautions When repairing the unit or measuring values.

- When Checking the INVERTER PBA refer to the Operation descriptions and "Reference" Section

INVERTER PBA Check

☞ SMPS Secondary Volt checking(+12V) : REG1:At both Terminals DC12V±0.8V



☞ SMPS Secondary Volt checking(+5V) : REG1:At both Terminals DC5V±0.4V



☞ SMPS Secondary Volt checking(+15V) : ZD501:At both Terminals DC15V±1.5V



- Check the connection of Door Panel PBA

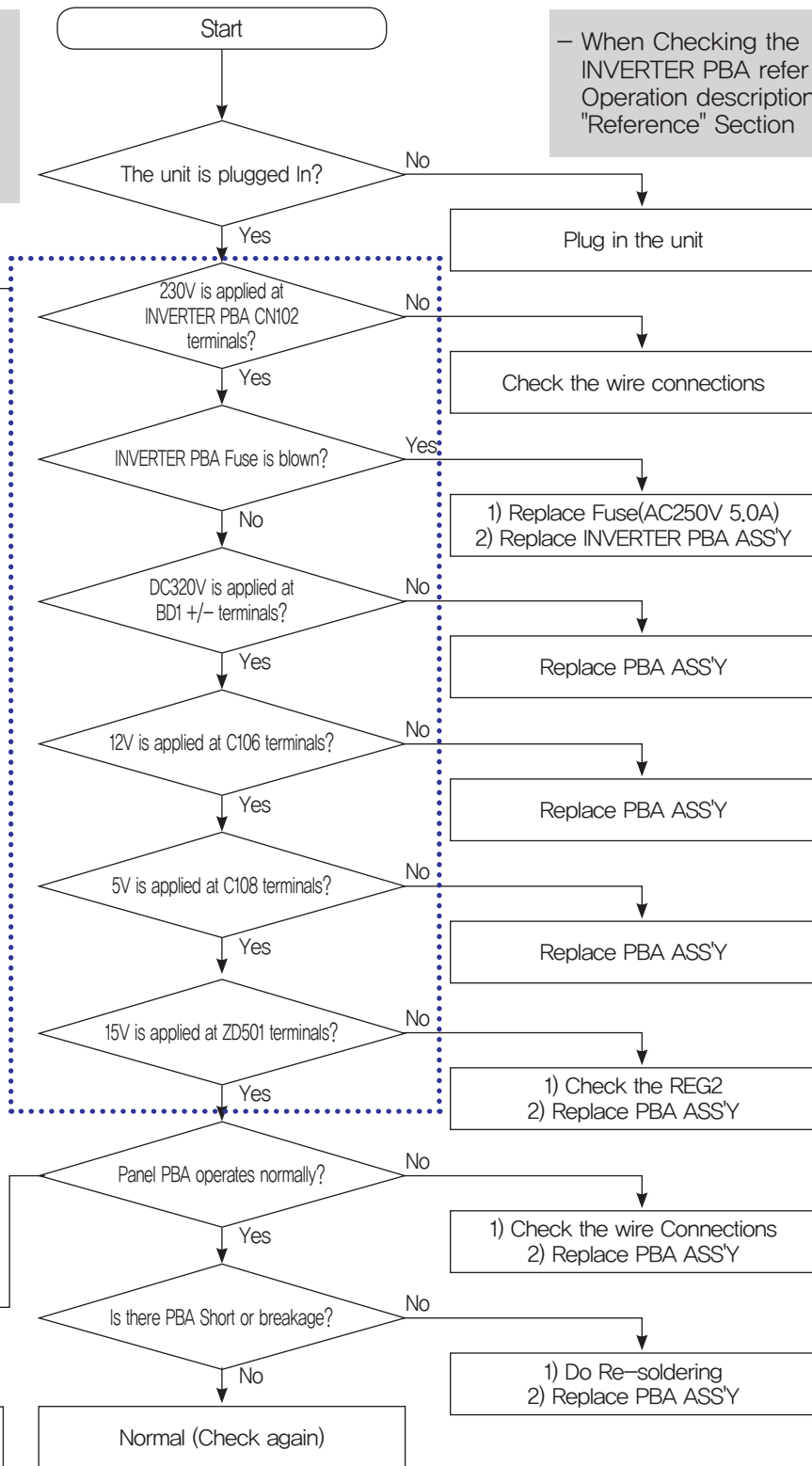

# 4. TROUBLESHOOTING

## 4-2-8) When the Compressor is not working (INVERTER PBA)

When the inverter PBA LED is ON, it indicates that the compressor does operate normally

Refer to the TEST Function in this manual

Forced Operation signal sound should be checked

0~800Hz 50% Duty Signal Output

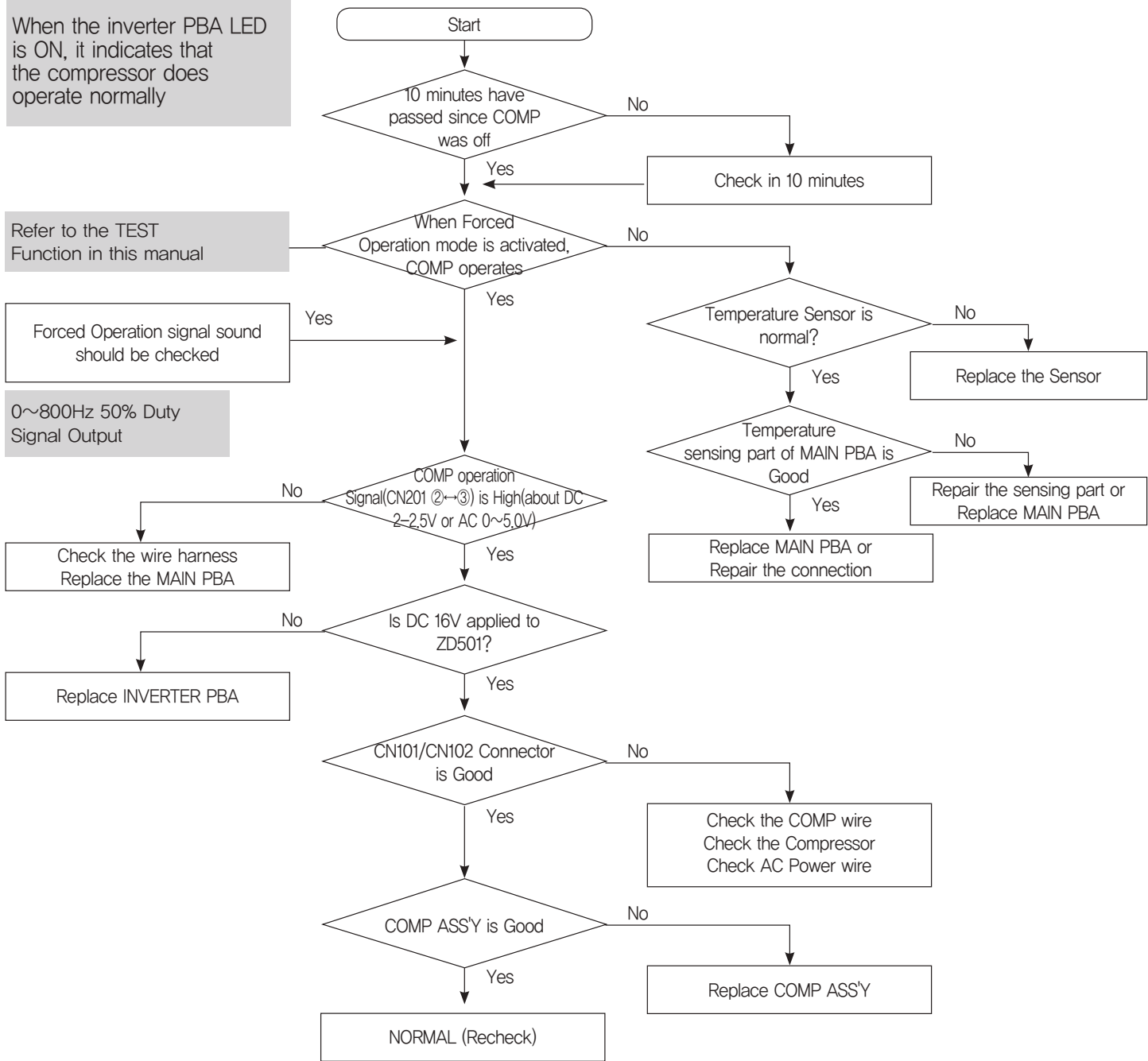

※ SMPS Primary Voltage checking(+16V) : REG1(+5V)  
Terminal(Input and GND) : DC16V±1.6V  
Terminal(Output and GND) : DC5V±0.2V



# 4. TROUBLESHOOTING

## 4-2-9) When the Compressor is not working (INVERTER PBA) A+++

When the inverter PBA LED is ON, it indicates that the compressor does operate normally

Refer to the TEST Function in this manual

Forced Operation signal sound should be checked

0~800Hz 50% Duty Signal Output

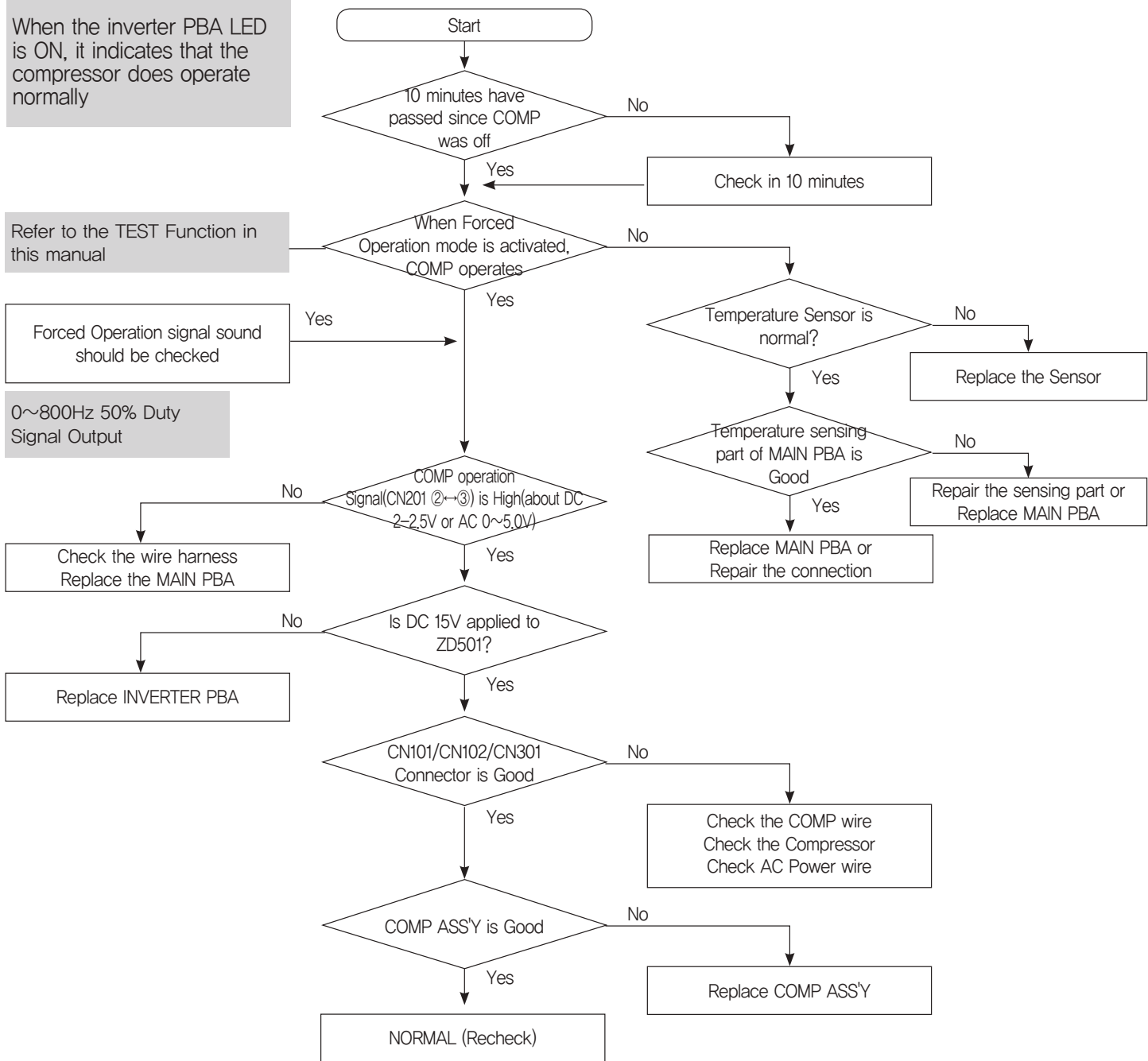

☞ SMPS Primary Voltage checking(+15V) : ZD501:At both Terminals DC15V±1.5V





# 4. TROUBLESHOOTING

## 4-2-10) When the unit keeps alarming (Buzzer Sound)

### Reference

1. Fridge / Freezer Door Open Alarm : It sends out an alarm sound when it passes over 2 minutes after the door is open. And, when the door remains open, it will keeps alarming every minute.
2. When the door is not closed properly, MICOM recognizes it as Door Open and sends out an alarm sound. When it passes over 10 minutes after it recognizes the Door Open, the room lamps will be off. At this time, when the Door is completely open, the Lamp will not be on right away, but after a while.

### ① When there is "Ding Dong" sound not stopping

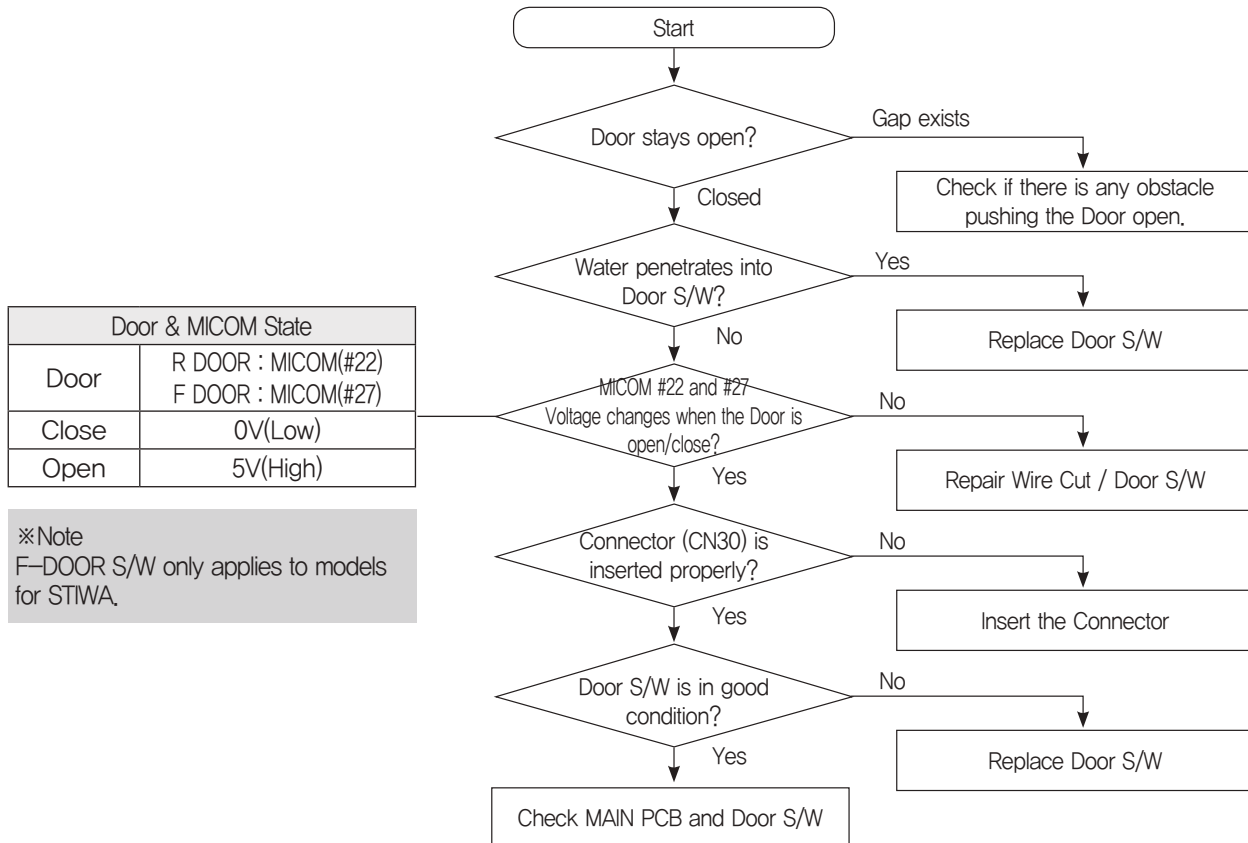

### ② When it keeps 'Beeping'

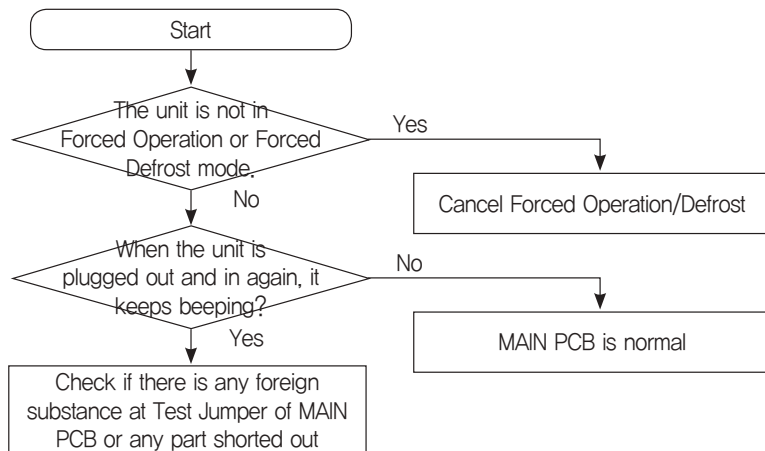

## 4. TROUBLESHOOTING

### ③ No Buzzer Sound

This model has a buzzer affixed on the MAIN PCB.  
If there is no buzzer sound upon button press, Forced Operation or Door Open, disconnect MAIN PCB and check if the buzzer is damaged or there is any defective soldering.  
(If it is not a soldering problem, it is recommended replacing MAIN PCB due to difficulties in repairing)  
※ It may not be able to check when it is a closed built-in environment and there is lots of noise around.

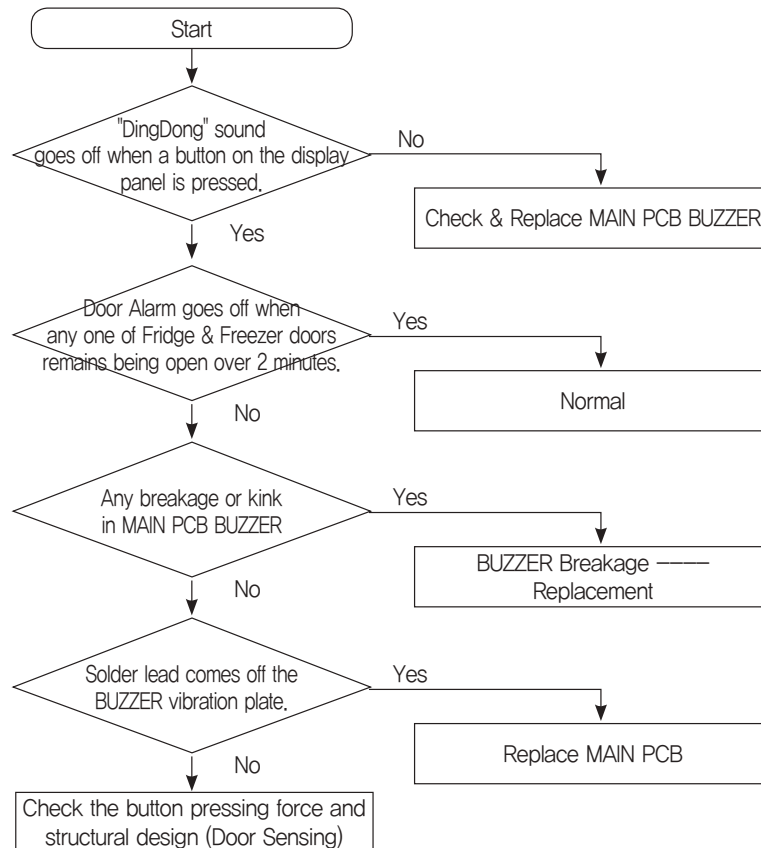

# 4. TROUBLESHOOTING

## 4-2-11) When PANEL PCB operates abnormally

① When PANEL PCB does not light up or partially does

– Display Assy Location  
 1. Internal Type : Top Table  
 2. External Type : Fridge Door/Top Hinge

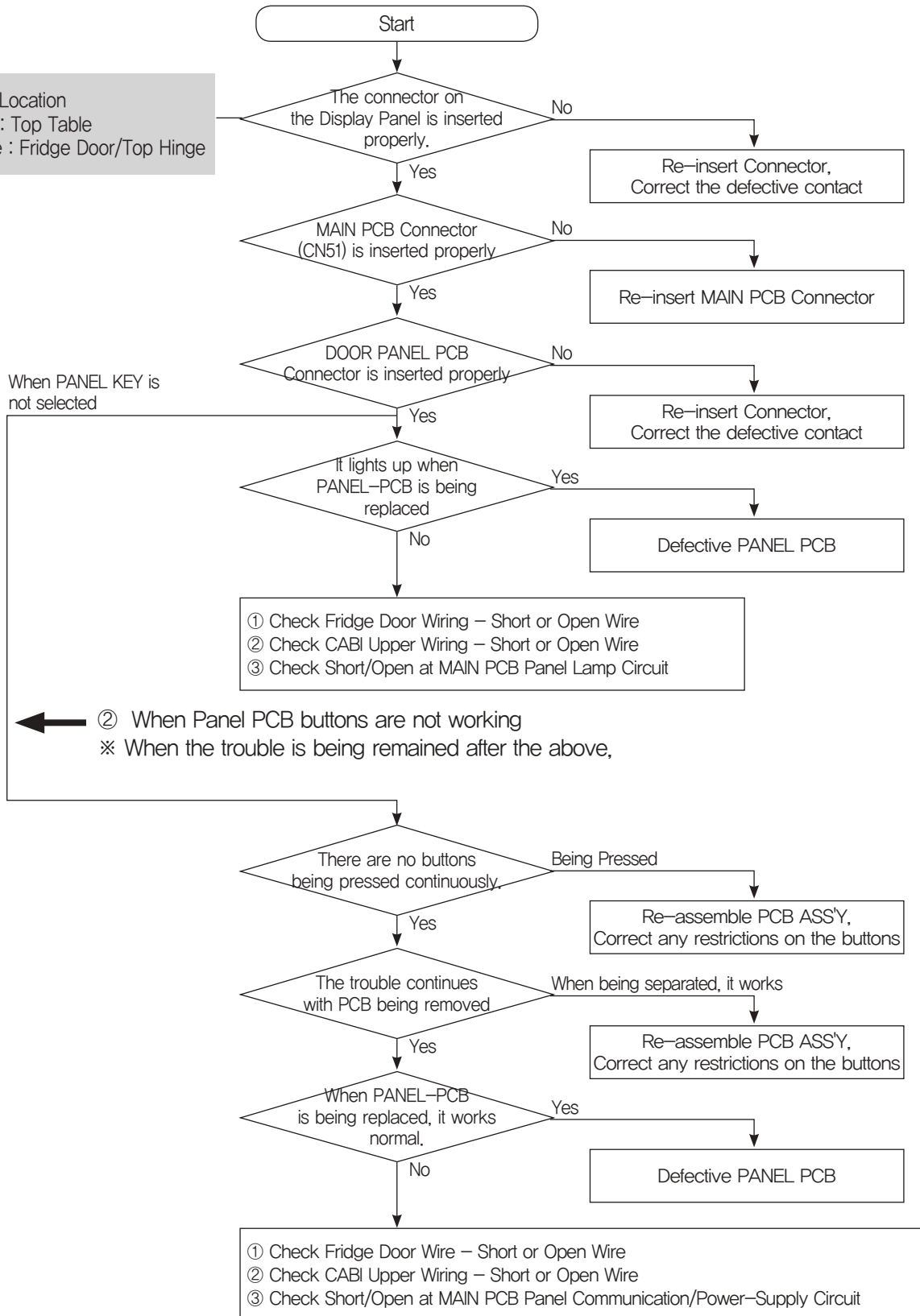

# 4. TROUBLESHOOTING

## 4-2-12) When the Room Lamp (LED) does not light up

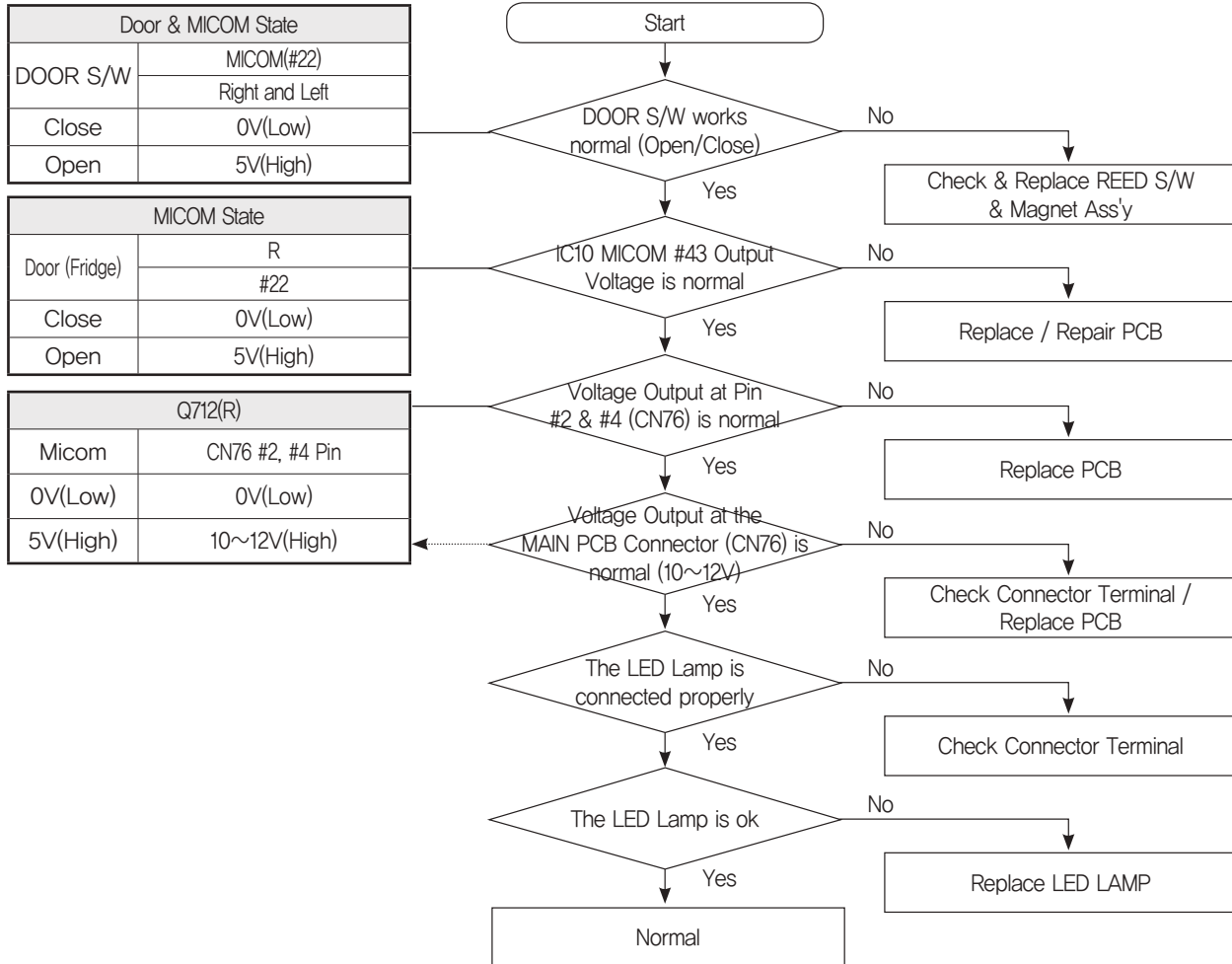

# 4. TROUBLESHOOTING

## 4-2-13) When Fridge Damper does not work

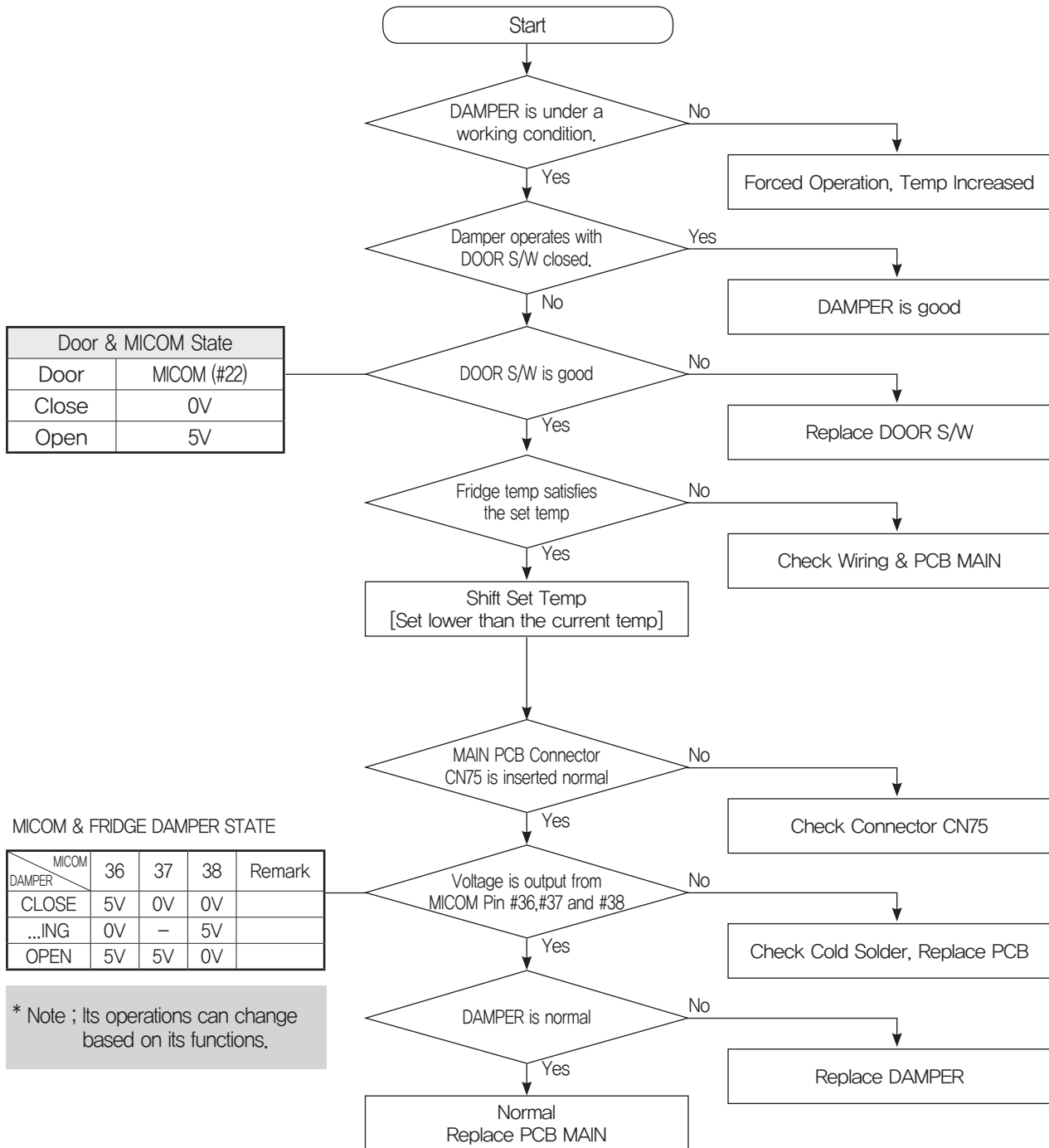

Door & MICOM State	
Door	MICOM (#22)
Close	0V
Open	5V

MICOM & FRIDGE DAMPER STATE

MICOM DAMPER	36	37	38	Remark
CLOSE	5V	0V	0V	
...ING	0V	-	5V	
OPEN	5V	5V	0V	

\* Note ; Its operations can change based on its functions.

# 4. TROUBLESHOOTING

## 4-2-14) When Cool Select Zone Damper does not work (Applies only to models with CSZ)

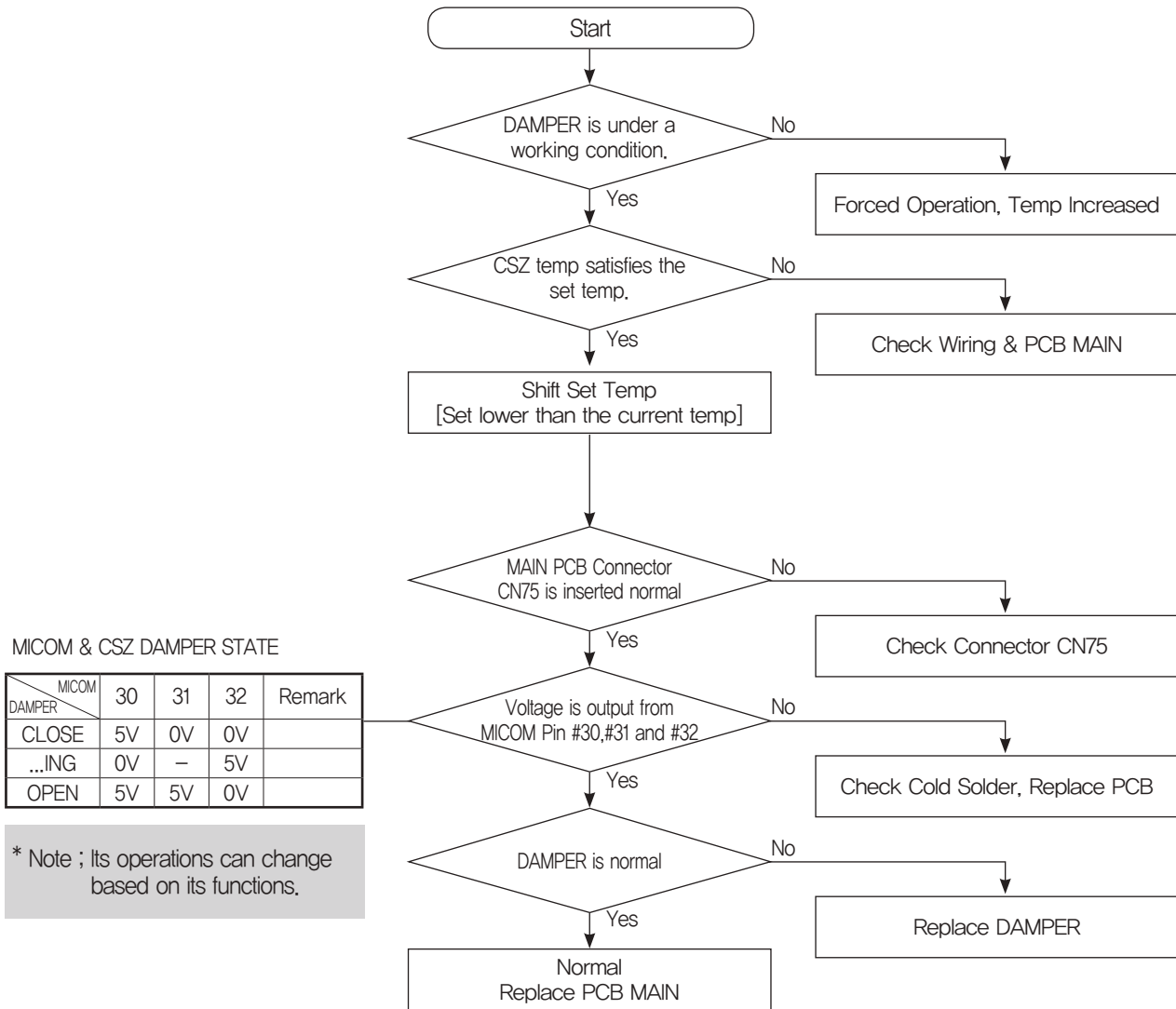

MICOM & CSZ DAMPER STATE

	MICOM			Remark
DAMPER	30	31	32	
CLOSE	5V	0V	0V	
...ING	0V	—	5V	
OPEN	5V	5V	0V	







\* Note ; Its operations can change based on its functions.

## 4. TROUBLESHOOTING

### 4-2-15) LED blinking frequency depending on protecting functions (Inverter PBA)

If Failure Condition is detected during compressor is operating, immediately stop Compressor operating and stand by 5 minutes. During this 5 minutes, RPM command signal is not available. It means, even if available RPM command signal is applied to the compressor, it does not work and keep standing by.

Blinking time is 1 second and dwell time is 2 seconds.

Description	LED Blinking Frequency	Remark
Normal Operation		N/A
Starting Failure		<ol style="list-style-type: none"> <li>1. Check the COMP terminals short (U,V,W)</li> <li>2. Check IPM Pins short of Inverter PBA</li> <li>3. Check IPM operating Voltage (under DC 13.5V)</li> <li>4. Other cases, check the COMP, cycle, etc.</li> </ol>
SPM Fault		
Position Sensing Error		<ol style="list-style-type: none"> <li>1. Check COMP wire connections (U,V,W)</li> <li>2. Check PBA Bottom side soldering state</li> <li>3. Other cases, check the COMP, cycle, etc.</li> </ol>
Motor Locked / Over RPM		<ol style="list-style-type: none"> <li>1. Check PBA Bottom side soldering state.</li> <li>2. Check Input voltage oscillation</li> <li>3. Other cases, check the COMP, cycle, etc.</li> </ol>
Under Voltage		<ol style="list-style-type: none"> <li>1. Check input voltage Normal Operating Voltage Range (AC 220V ~ 240V)</li> <li>2. Check PBA Bottom side soldering state.</li> </ol>
Over Voltage		

LED blinking frequency depending on protecting functions If the same blinking, After 5 minutes, Follow the Remarks.

# 5. PCB/PBA DIAGRAM

## 5-1) PART Layout (Main Board)

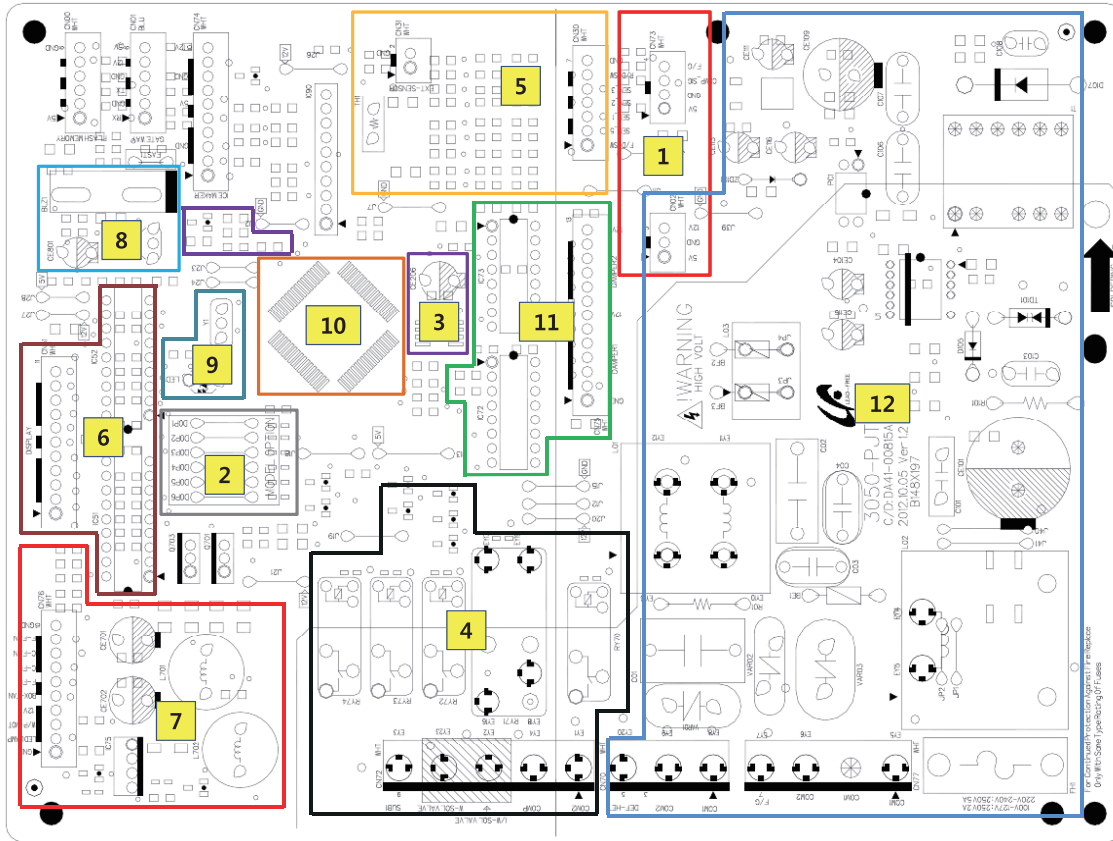

1. Inverter COMP. Signal Section
2. Section for Diode Option Setting
3. EEPROM : Storing/Writing various data.
4. This Relay Section controls the AC Load and operates by receiving the driving signals for Micom via the Sink IC.
5. It receives various sensor signals and delivers them to MICOM after eliminating noises, and it detects the Fridge Door open and the Operation of the Water S/W.
6. MAIN → PANEL PCB Operation Control
7. Fan Motor / LED Lamp / Water Pump Driver It supplies 8V ~ 12V to the motors depending on load types.
8. Buzzer Alarm : It sends out periodic alarm sounds when a button is pressed or when the door is open.
9. MICOM, Clock Generation, Software Resetting
10. Main Micom(CPU)
11. It controls the operation of the Fridge Damper and the Cool Select Zone Damper.
12. Converting AC Power into DC (POWER SOURCE UNIT)

This document can not be used without Samsung's authorization.



## 5. PCB/PBA DIAGRAM

### 5-2) Parts Layout (Inverter Board)

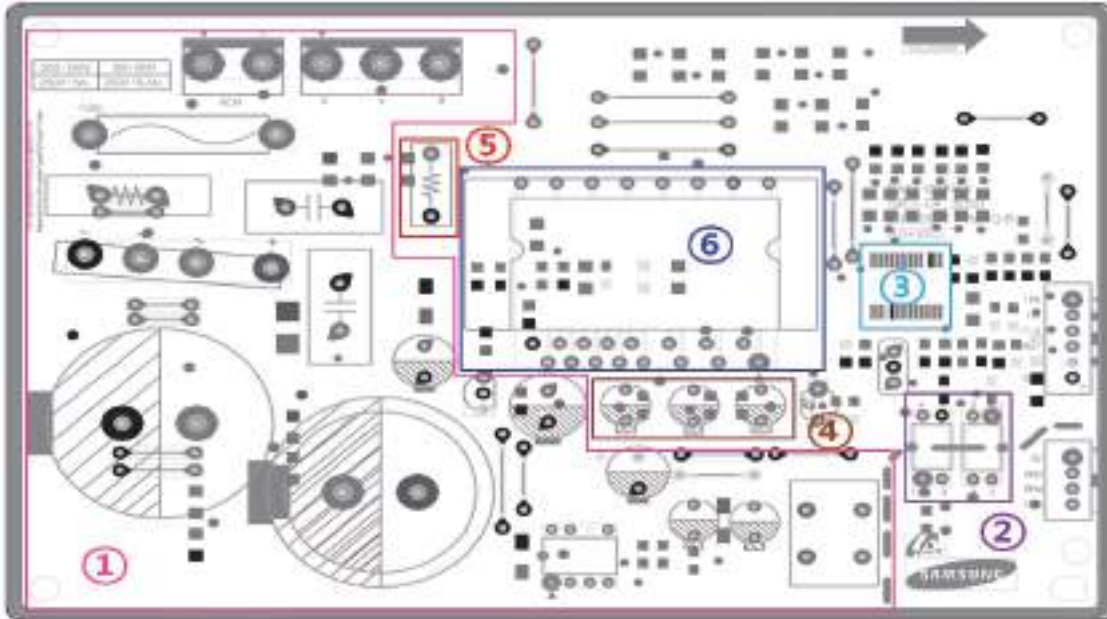

1. PBA Power Supply : Supplies DC 16V and 5V to the Inverter circuit for the Compressor control.
2. COMP Driving / Feedback Circuit  
It receives the COMP(MSV) operation signals from the Main PBA and feedbacks the inverter errors to the Main PBA.
3. Micom (uPD78F1201)
4. BOOTSTRAP Charger : It is an independent power circuit for the driving of the IPM High-Phase IGBT.
5. Current Sensing Circuit : It detects the currents taken by the Shunt resistance and does the PWM DUTY control.
6. IPM (IGCM04G60HA)

## 5. PCB/PBA DIAGRAM

### 5-3) Parts Layout (Inverter Board) A+++

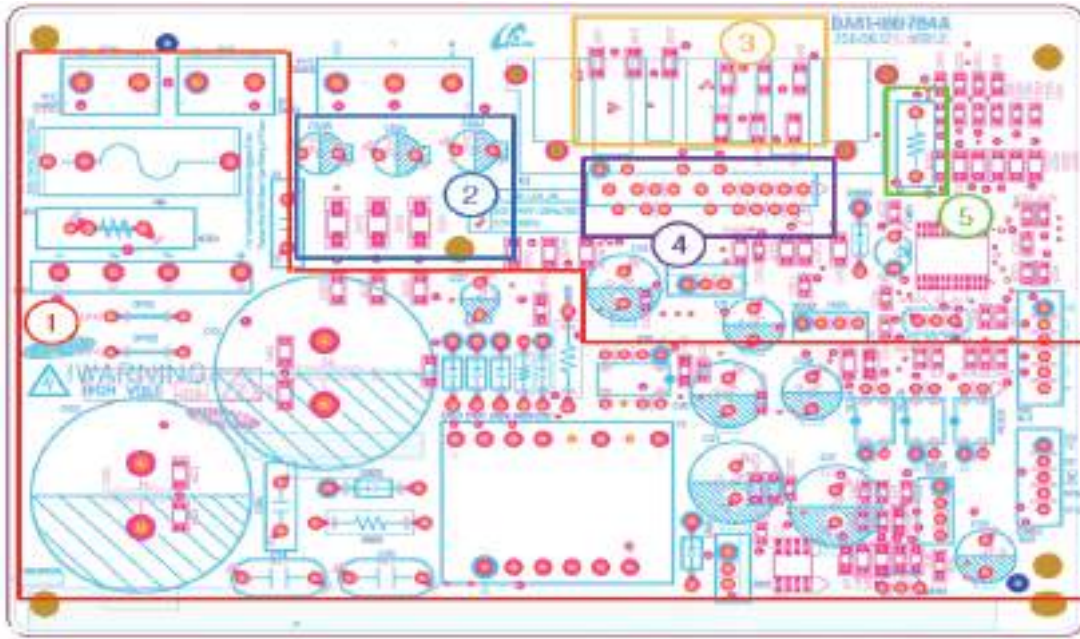

1. PBA Power Supply : Circuit changing the input power to the fridge control power with SMPS.  
After converting to 12V and 5V, supply them to Main PBA.  
After converting to 15V and 5V, use them for inverter control.
2. Bootstrap Circuit : Independent Power Circuit for IPM High-Phase Driving.
3. Position Sensing Circuit : Detection of Rotor Position by monitoring the U/V/W-Phase of Compressor.
4. IPM : It is a Power Module which consists of HVIC(1), IGBT(6) and Diode(6) and drives the compressor with IGBT ON/OFF controlling at the Micom.
5. Current Sensing Circuit : It detects the currents taken by the Shunt resistance and does the PWM DUTY control.

# 5. PCB/PBA DIAGRAM

## 5-4) Connector Layout & Description (Main Board)

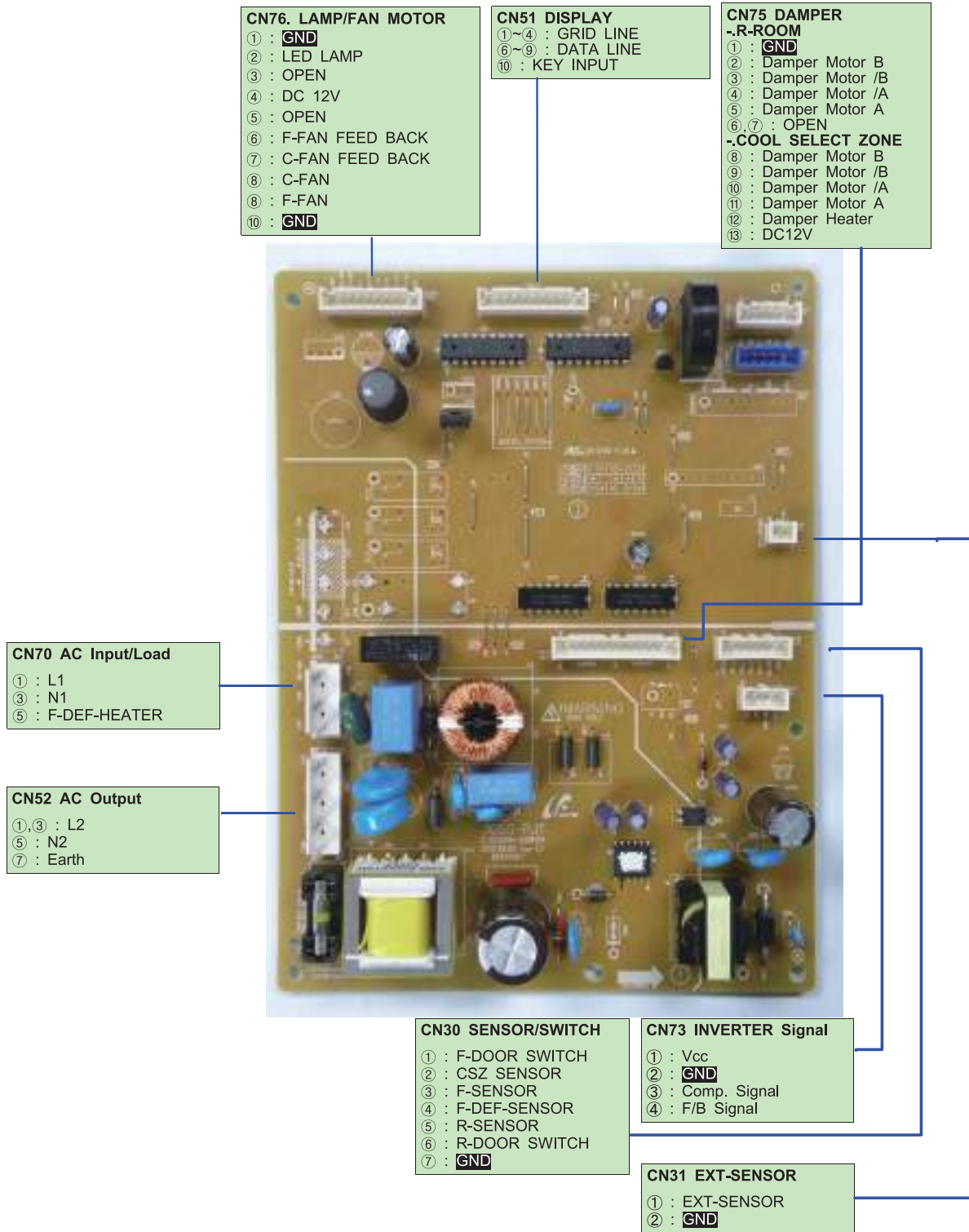

This document can not be used without Samsung's authorization.

# 5. PCB/PBA DIAGRAM

## 5-5) Connector Layout & Description (Main Board) A+++

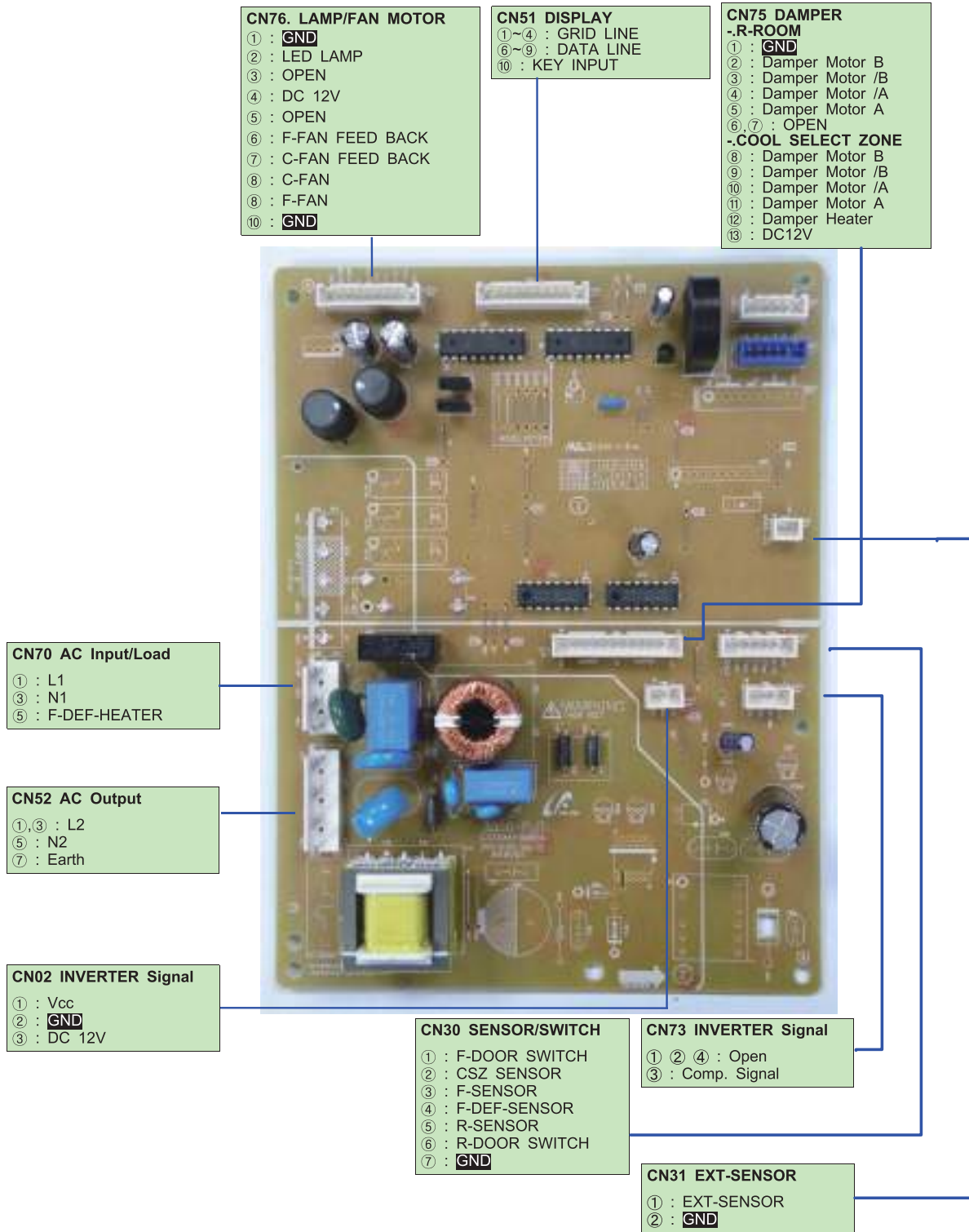

This document can not be used without Samsung's authorization.



## 5. PCB/PBA DIAGRAM

### 5-6) Connector Layout & Description (Main board) TWIN COOLING



This document can not be used without Samsung's authorization.

## 5. PCB/PBA DIAGRAM

### 5-7) Connector Layout & Description (Inverter Board)

AC IN COMP

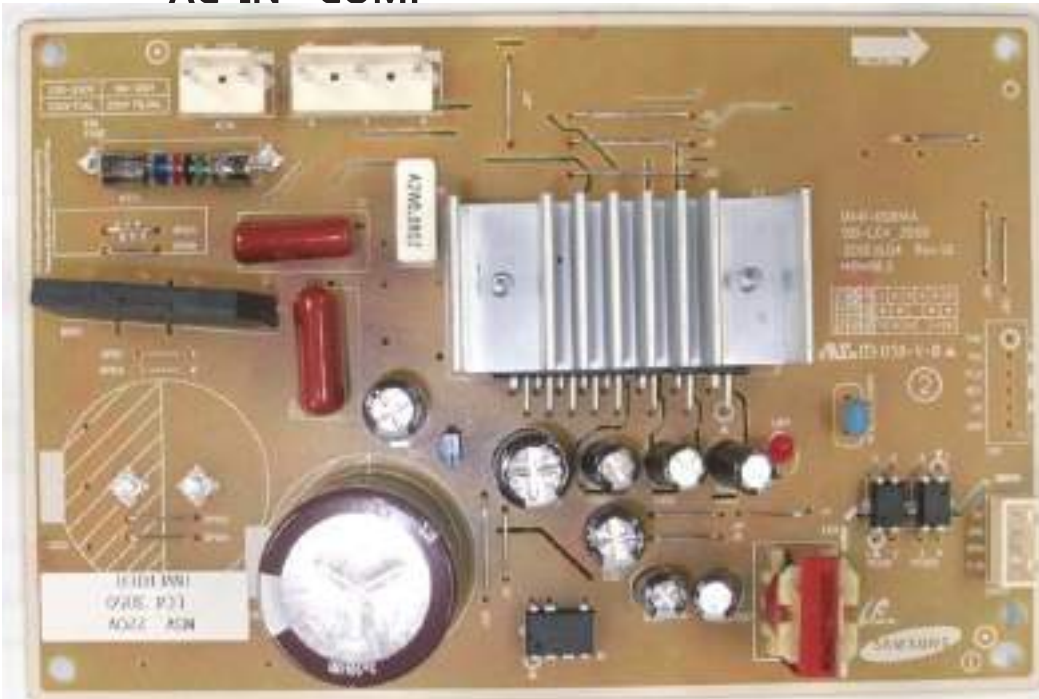

This document can not be used without Samsung's authorization.

## 5. PCB/PBA DIAGRAM

### 5-8) Connector Layout & Description (Inverter Board) A+++

AC IN    OLP    COMP



- ① DC12V
- ② DC5V
- ③ GND
- ④ RPM
- ⑤ F/B

## 5. PCB/PBA DIAGRAM

### 5-9) Connector Layout & Description (Inverter Board) 3050 2M A+++



This document can not be used without Samsung's authorization.



## 5. PCB/PBA DIAGRAM

### 5-10) Connector Layout & Description (PBA Sub)



## 5. PCB/PBA DIAGRAM

### 5-11) Connector Layout & Description (PBA Coil Filter)



This document can not be used without Samsung's authorization.

# 6. WIRING DIAGRAM

## 6-1) Wiring Diagram (A+, A++)

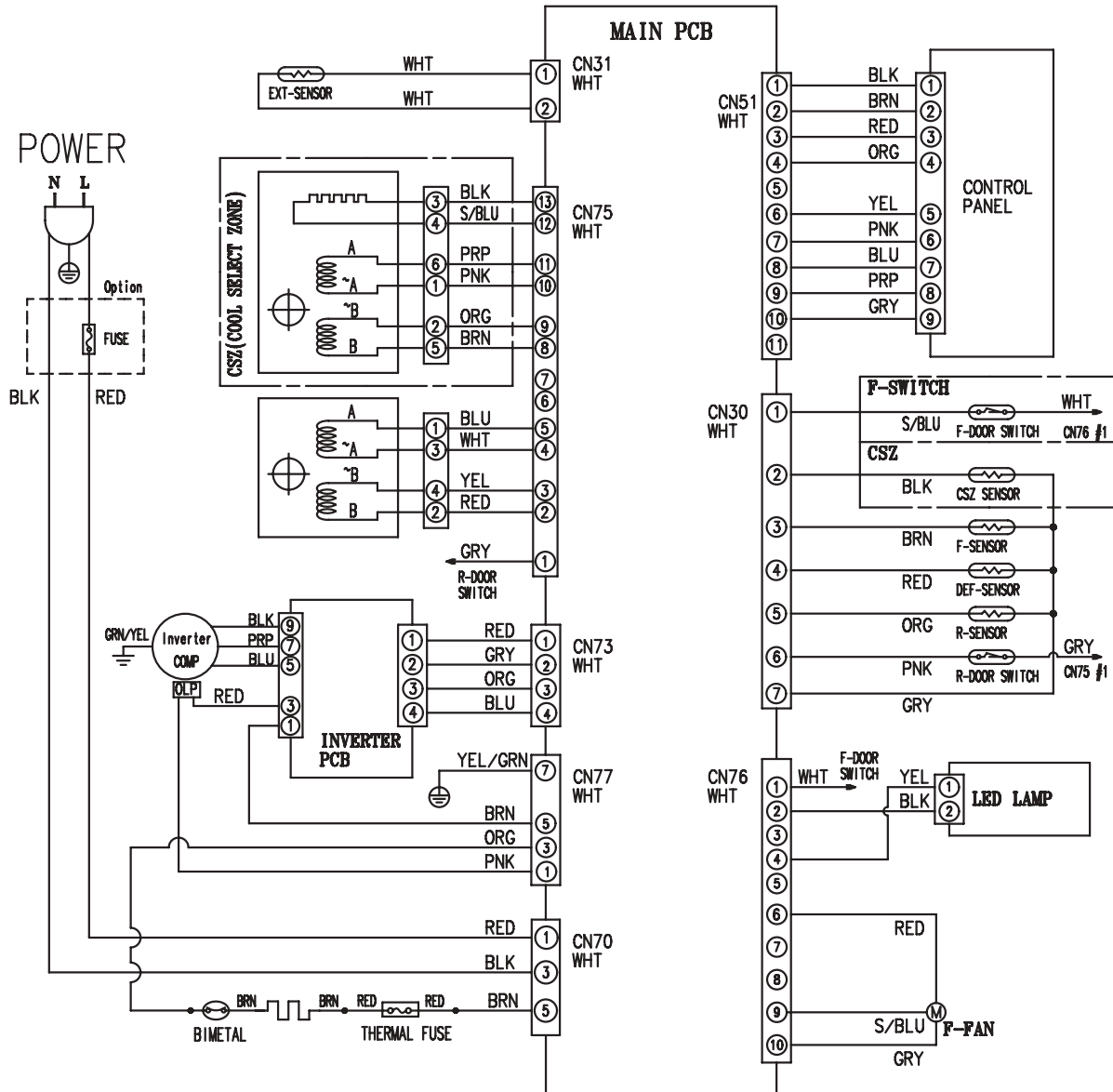

[OPTION TABLE]  
9th Character at Model name

9th Character	CSZ	F-SWITCH
C	0	0
D	X	X

# 6. WIRING DIAGRAM

## 6-2) Wiring Diagram (A+++)

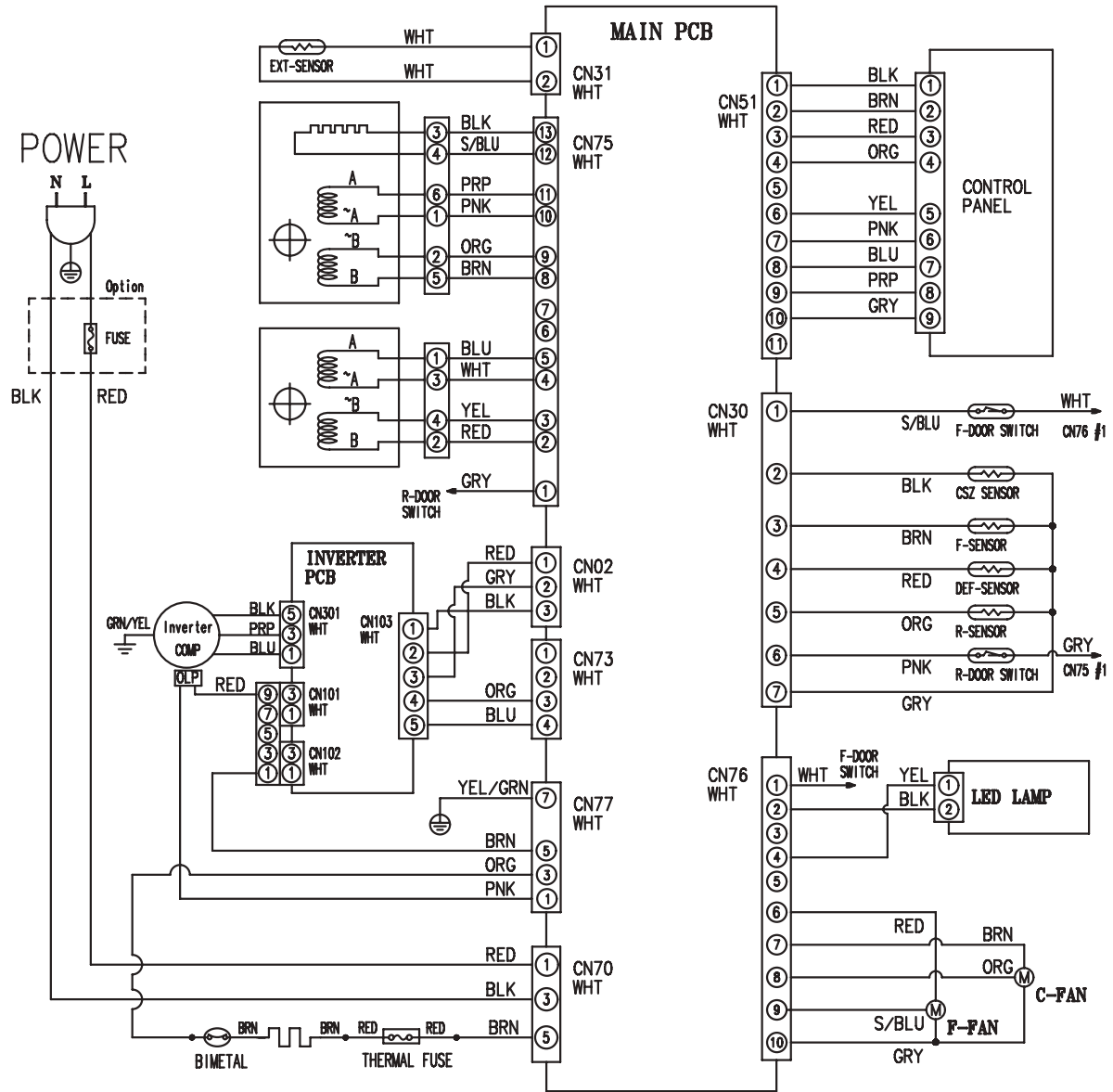

This document can not be used without Samsung's authorization.

# 6. WIRING DIAGRAM

6-3) 3050-2M A+++

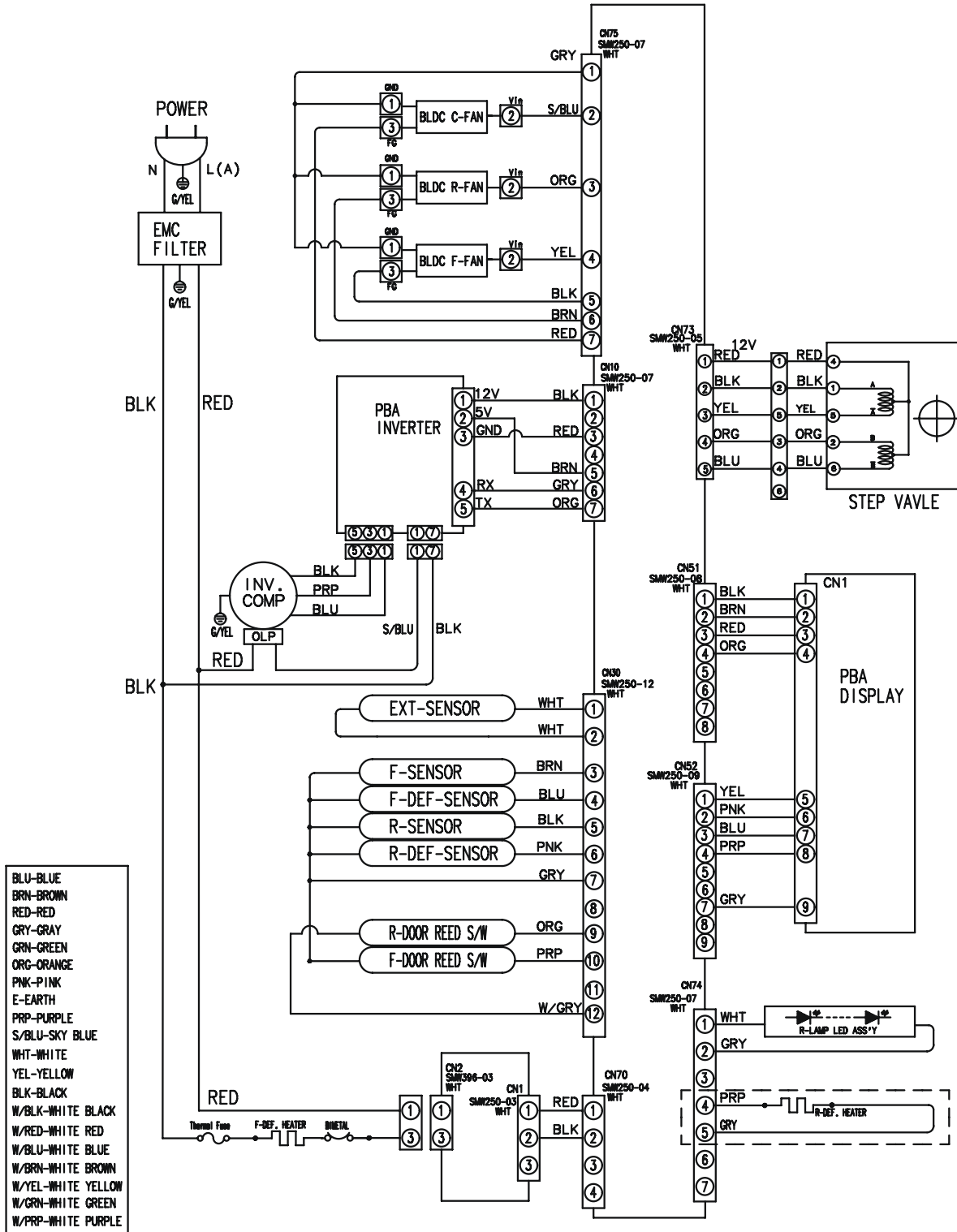

This document can not be used without Samsung's authorization.

# 6. WIRING DIAGRAM

6-4) 3050-2M A++

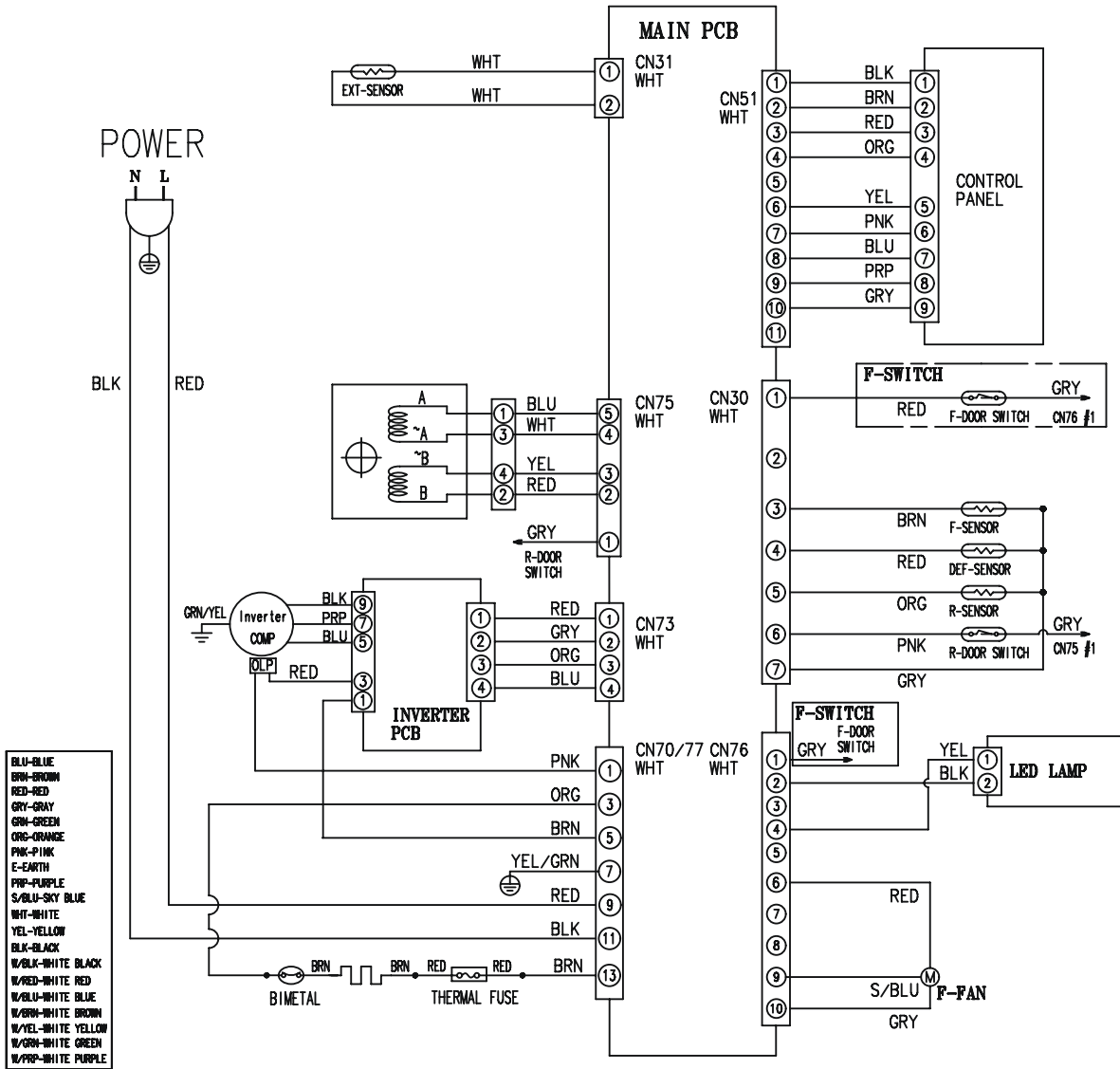

This document can not be used without Samsung's authorization.

# 7. BLOCK DIAGRAM

## 7-1) PBA Main

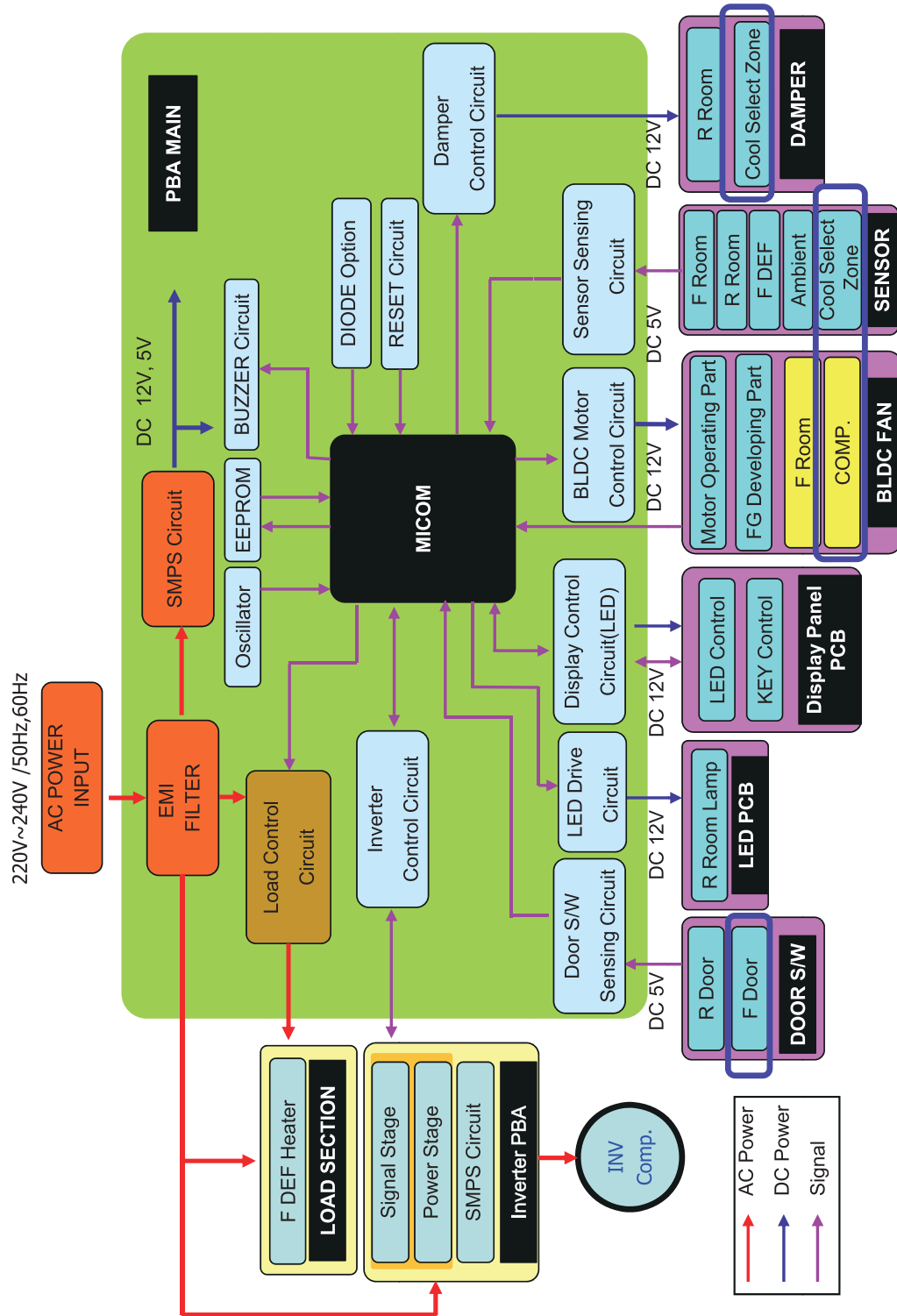

This document can not be used without Samsung's authorization.

# 7. BLOCK DIAGRAM

## 7-2) PBA Main A+++

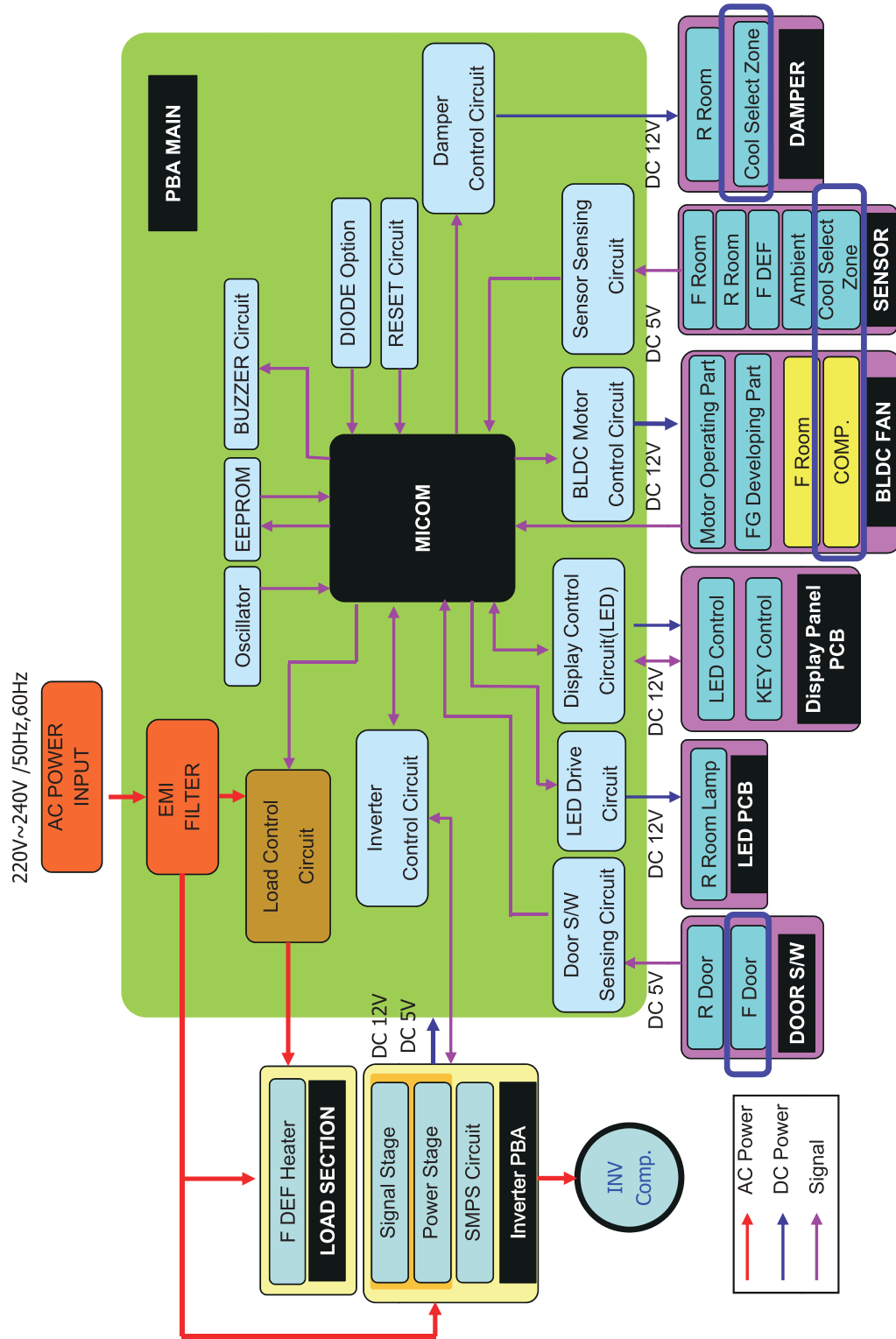

This document can not be used without Samsung's authorization.



# 7. BLOCK DIAGRAM

## 7-3) PBA Inverter

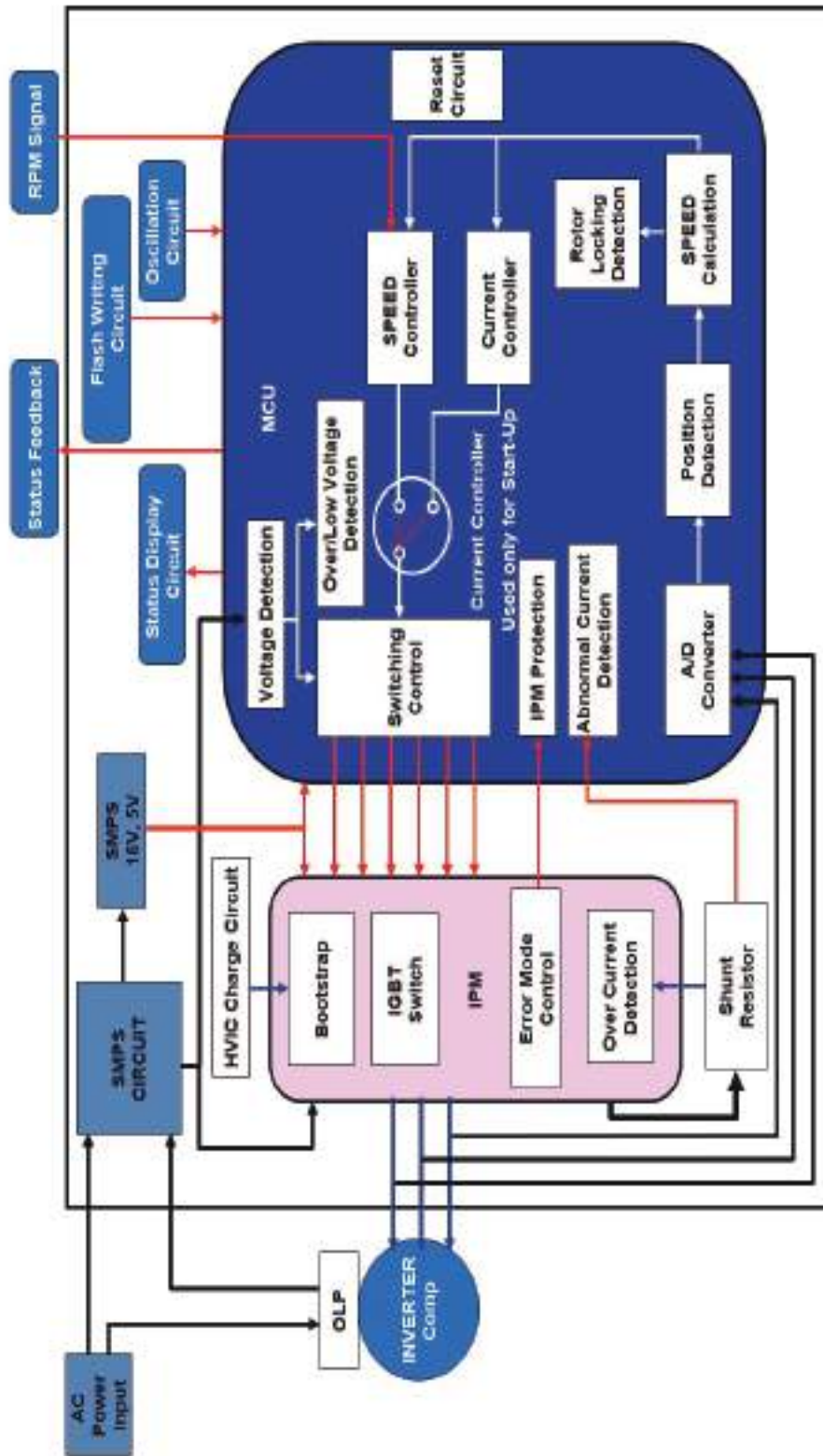

This document can not be used without Samsung's authorization.

# 7. BLOCK DIAGRAM

## 7-4) PBA Inverter A+++

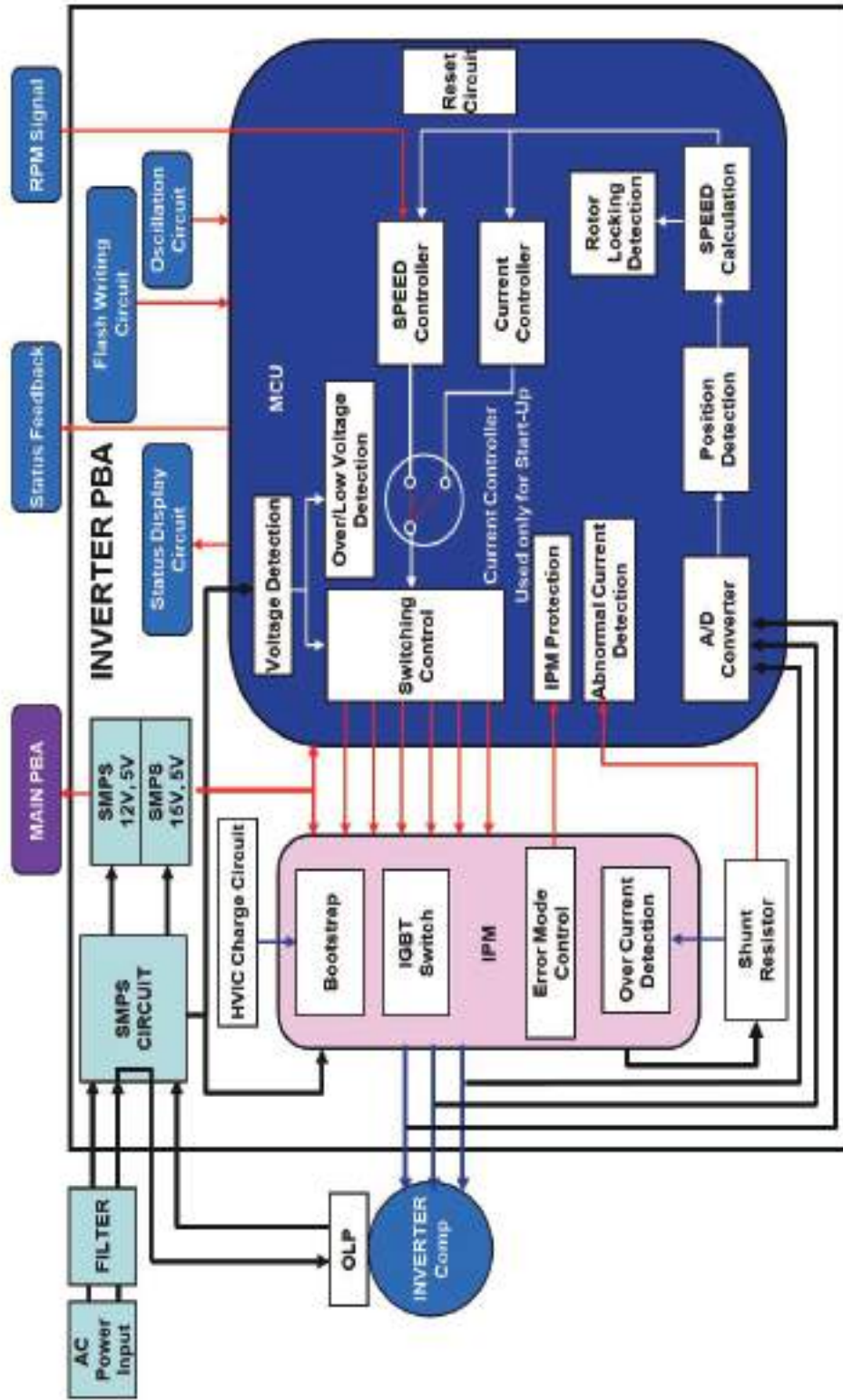

This document can not be used without Samsung's authorization.

# 7. BLOCK DIAGRAM

## 7-5) Nomenclature

<3050 2M BMF : CIS>

	1	2	3	4	5	6	7	8	9	10	11	12	13	14
BMF	Capacity	Series	Feature 1 (Material)	Feature 2 (Material)	Feature 3 (Energy)	Color	TPA	Country						
Code	Capacity	Series	Feature 1 (Material)	Feature 2 (Material)	Feature 3 (Energy)	Color	TPA	Country	Energy	Coating	Metal Coating	Coat	COI	Country
85000	0	000	Internal	None	0	0000	0		0	None (All Around Coating)	X	0000	0	
	1	000	Internal	None	0	0000	0		0	None (All Around Coating)	X	0000	0	
	2	000	External	None	0	0000	0		0	None (All Around Coating)	0	0000	0	
	3	000	External	Bar	0	0000	0		0	None (All Around Coating)	0	0000	0	
	4	000	External	None	0	0000	0		0	None (All Around Coating)	0	0000	0	

# 8. REFERENCE INFORMATION

<3050-BMF>

Platform Architecture Base																	
1	2	3	4	5	6	7	8	9	10	11	12	13	14				
A	A	1	1	A/1	A/1	A/1	A	A	A	A	/	/	Buyer				
Product Type	Capacity	Year	Door Option	Handle	Interior	Energy	Exterior Color	W	V	B	C	M	G	S	P	S	L
R	B	2	3	F	E	J	N	B	B	C	G	S	P	S	L		
				A+++	E	J	N	B									
				A++	E	J	N	C									
				A++ (Water)	D	J	N	C									
				A+	W	J	N	D									
				A+	S	J	N	D									
					E	R	C										
							M										

■ No.6, Door Option

Code Name	Description	Remarks
S	Basic, Internal LED (Electronic Type)	
E	Basic, External LED (Electronic Type)	
W	Water, Internal LED (Electronic Type)	Only for A+ Class
D	Water, External LED (Electronic Type)	Only for A+ Class

■ No.7, Handle

Code Name	Description	Remarks
J	Bar	
R	Recess	

■ No.8, Interior Option

Code Name	Description
M	Slide out shelf, Bottle rack, Veg&fruit box, 2 EA (Only for Good Class)
N	Slide out shelf, Bottle rack
C	Slide out shelf, Bottle rack, Cool pack (Freezer)
B	Slide out shelf

■ No.9, Energy

Code Name	Description
D	A+ (For CIS : A), Bottle rack (metal, half)
C	A++ (For CIS : A+), Fresh choice box, Bottle rack (metal)
B	A+++ (For CIS : A+++), Fresh choice box, Bottle rack (metal)

■ No.10~11, Color

Code Name	Color
SL	EZ clean steel (ALF)
SP	New VCM
MG	Metal graphite
EF	Vanilla beige
BC	Empire black
WW	Snow white

Only for A+ Class  
Only for A+ Class



272, Oseon-Dong, Gwangsan-Gu,  
Gwangju-City, Korea, 506-253  
TEL : 82-62-950-6193, 6896  
FAX : 82-62-950-6829

- For the latest parts information, Please access to our service web site  
( • North America : <http://service.samsungportal.com>  
• Latin America : <http://latin.samsungportal.com>  
• CIS : <http://cis.samsungportal.com>  
• Europe : <http://europe.samsungportal.com>  
• China : <http://china.samsungportal.com>  
• Asia : <http://asia.samsungportal.com>  
• Mideast & Africa : <http://mea.samsungportal.com>)

– This Service Manual is a property of Samsung Electronics Co., Ltd.  
Any unauthorized use of Manual can be punished under applicable  
International or domestic law. –